



Regd. office:  
**Goldmedal Electricals Pvt. Ltd.**  
A/303, Kemp Plaza, Off Link Road,  
Mindspace, Chincholi Bunder, Malad (W),  
Mumbai-400064, Maharashtra, India

Web: [www.goldmedalindia.com](http://www.goldmedalindia.com)  
Email: [info@goldmedalindia.com](mailto:info@goldmedalindia.com)  
Customer care no.: 91-9711 09 09 09

Goldmedal, Curve, Nixon, Air, Ringo, 90 Degree,  
Gifa & Cloud9 are registered trademarks  
of Goldmedal Electricals Pvt. Ltd.  
Copyright protected by Goldmedal. No part of this  
pricelist & catalogue may be printed or duplicated  
without consent of Goldmedal Electricals Pvt. Ltd.  
Patent, Trademark & Designs protected.  
Infringement is liable for prosecution. Imitation  
of graphics is a punishable offence.  
Brand identity, concept & design of  
Goldmedal Electricals Pvt. Ltd.



Scan for the  
AMAZING



MARCH 2K26 1ST EDITION  
PLWDA503261



WIRING DEVICES PRICELIST

# Switch to the amazing



EDITION MAR 2K26  
PRODUCT & PRICING MANUAL



# Experience the amazing!

How *amazing* can electrical switches, lights, fans, and wires be? Unbelievably so, if you look at the Goldmedal range of products. First of all, they are all so fashionable to look at – from their sleek lines to their gorgeous colours and finishes – every product looks like a fashion accessory for your home.

But you don't have to go by their looks alone. Consider their functionality and you'll appreciate why they are so amazing! Whether it is home automation products, fans, LED lights or even simple products like switches or home appliances such as irons and geysers, every product is engineered with precision, keeping in mind the unique needs and tastes of Indian homes. The result? A perfect harmony of form and function that elevates your everyday living.

As someone who appreciates great style and loves incorporating such products in their daily life, I'm absolutely delighted to be associated with Goldmedal. Their products complement my sense of fashion and I can't wait for you to experience the same joy they bring me.

Trust me on this, you'll be convinced once you see them in action!

**Jacqueline Fernandez**

Brand Ambassador

*Jacqueline*



CELEBRATING  
EXCELLENCE



reddot winner 2025

loom.

Crafted for India. Celebrated by the World.

The Loom switch by Goldmedal has been awarded the prestigious Red Dot Award - one of the highest honours for design excellence. Integrating fabric as a functional element, Loom is a bold reimagination of a household essential. This global recognition reaffirms Goldmedal's commitment to creating everyday products that are not just functional, but truly world-class.



winner 2026

ROOTS

Rooted in Nature. Alive with Light.

The ROOTS Lighting System by Goldmedal has been recognised with the iF Design Award 2026, joining the ranks of the world's most celebrated design achievements. A living, modular installation that breathes and responds to the air around it, ROOTS reimagines light not as a utility, but as a presence. One that thinks, adapts, and glows with quiet purpose. A proud reflection of Goldmedal's vision to keep pushing the boundaries of light and design.



# Contents

Sec 01 Curve Modular Inserts	10-23
Sec 02 Nixon Modular Inserts	24-41
Sec 03 Modular Cover Plates	42-59
Sec 04 Air Modular Inserts	60-71
Sec 05 Air Modular Cover Plates	72-81
Sec 06 Junction Box	82-85
Sec 07 Curve Plus	86-107
Sec 08 Curve Plus Pro	108-113
Sec 09 DBs & MCBs	114-141

## A visual symphony that elevates our existence.

Colours influence our everyday lives in ways we may not always realize. They surround us in every aspect of our lives, painting the world with a vibrant palette that evokes emotions, ignites imagination, and shapes our perceptions. It plays a pivotal role in human expressions and creations. They awaken a sense of wonder, reminding us of the awe-inspiring wonders that surround us. Therefore, let us fill our lives with the beauty of colours and create a life adorned with shades that make each moment more meaningful.

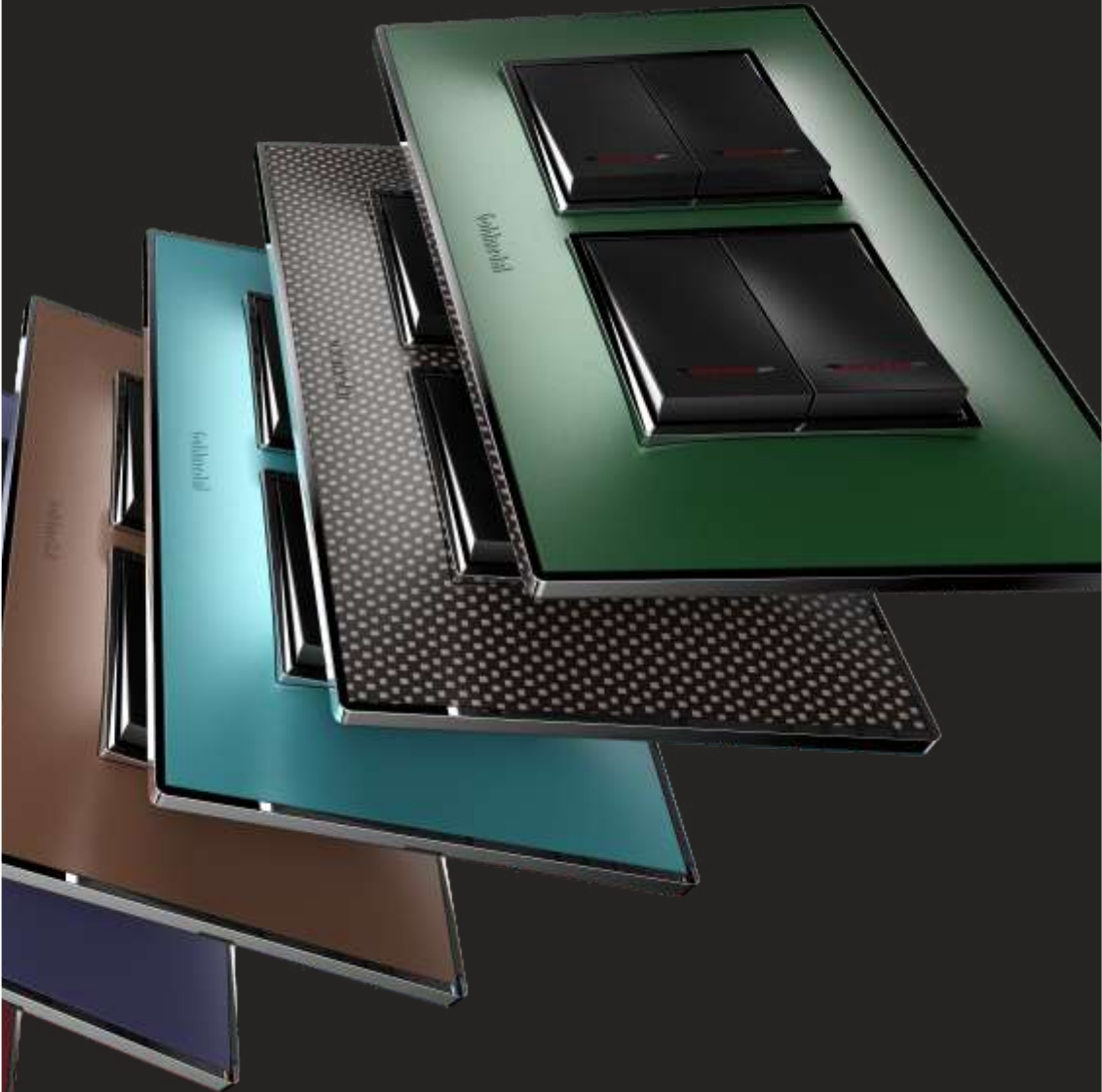

# Endless possibilities for modern living

Nixon represents a new era in stylish living. Crafted in contemporary styles with minimalistic profiles in classical as well as revolutionary shades, Nixon introduces a variety of high quality lifestyle products that will change the way you look at modular switches and functions. All Nixon products are compatible with a variety of Goldmedal plates, including the Wega, making the possibilities for form, finish and colours, simply endless.



Wega Plate -  
G-Dip Switch with Indicator



Wega Plate -  
G-Click Switch with Indicator



Wega Plate -  
i-Touch Wi-Fi Switch



Wega Plate -  
Step Marker with Smart Dimming



Wega Plate -  
i-Sense Senso Switch



Wega Plate -  
65W C Type Fast Charger



Wega Plate -  
8 Step Full Rotary Fan Regulator



Wega Plate -  
32A DP Operated by Key Tag

Comfort & reliability built  
on high-performance material.

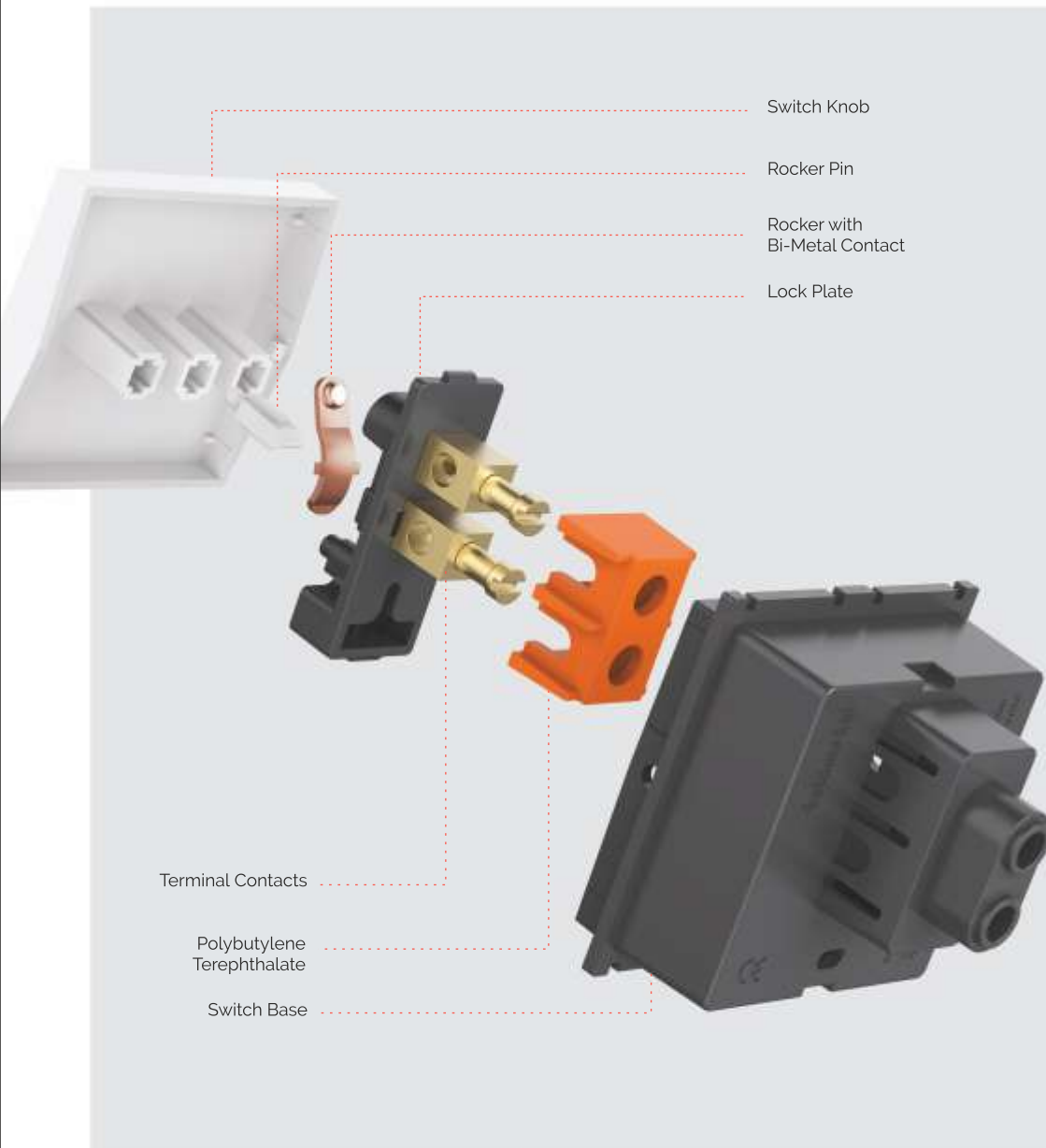

### Polybutylene Terephthalate (PBT) Switches

Switches are superior quality electrical devices that are easy on the eye and extremely delightful to use. Making the smooth user experience possible is a combination of components that are precisely crafted from high-quality materials. The terminal contacts are supported by a casing of polybutylene terephthalate (PBT) within a PC base. With a high melting point above 200 degree Celsius, the PBT casing insulates every part of the switch from any electrical or thermal leakages. The thoughtful construction of the Goldmedal switches thus ensures greater reliability and increased durability over its long years of service.





Code	Item	MRP ₹		Pkg.
		White Jazz	Digital Chrome Voltage Grey	
<b>10AX SWITCHES 240V~ ( 1 Module )</b>				
101001	1 Way Switch	90.00	100.00	20/600
101002	1 Way Switch with Indicator (LED)	157.00	173.00	20/600
101003	2 Way Switch	186.00	204.00	20/600
101004	Bell Push Switch	181.00	201.00	20/600
101005	Bell Push Switch with Indicator (LED)	190.00	212.00	20/600

Code	Item	MRP ₹		Pkg.
		White Jazz	Digital Chrome Voltage Grey	
<b>10AX SWITCHES 240V~ ( 2 Module )</b>				
102010	1 Way Switch	148.00	161.00	10/300
102011	1 Way Switch with Indicator (LED)	160.00	177.00	10/300
102012	2 Way Switch	230.00	253.00	10/300
102013	Bell Push Switch	238.00	261.00	10/300
102014	Bell Push Switch with Indicator (LED)	265.00	290.00	10/300

Code	Item	MRP ₹		Pkg.
		White Jazz	Digital Chrome Voltage Grey	
<b>6AMP BELL PUSH 240V~ ( 2 Module )</b>				
102015	Bell Push with Luminous Name Plate 240V~ 50-60Hz LED circuit with diffuser	331.00	363.00	10/300

Code	Item	MRP ₹		Pkg.
		White Jazz	Digital Chrome Voltage Grey	
<b>20AMP / 25 AMP SWITCHES 240V~ ( 1 Module )</b>				
101020	20A 1 Way Switch	241.00	263.00	20/600
101021	20A 1 Way Switch with Indicator (LED)	259.00	286.00	20/600
101022	20A 2 Way Switch	281.00	309.00	20/600
101023	25A 1 Way Switch	289.00	318.00	20/600

Code	Item	MRP ₹		Pkg.
		White Jazz	Digital Chrome Voltage Grey	
<b>20AMP / 25AMP SWITCHES 240V~ ( 2 Module )</b>				
102025	20A 1 Way Switch	266.00	292.00	10/300
102026	20A 1 Way Switch with Indicator (LED)	292.00	320.00	10/300
102027	20A 2 Way Switch	325.00	358.00	10/300
102028	25A 1 Way Switch	336.00	368.00	10/300

Code	Item	MRP ₹		Pkg.
		White Jazz	Digital Chrome Voltage Grey	
<b>32AMP DP SWITCHES 240V~</b>				
102031	32A DP Switch with Indicator (LED) - 2M	478.00	527.00	10/300
102032	32A Nano DP Switch with Indicator (LED) - 2M	526.00	580.00	10/300

Code	Item	MRP ₹		Pkg.
		White Jazz	Digital Chrome Voltage Grey	
<b>6AMP SOCKET 240V~</b>				
102038	6A 3 Pin Socket (2M) with safety shutter	162.00	179.00	10/450

Code	Item	MRP ₹		Pkg.
		White Jazz	Digital Chrome Voltage Grey	
<b>6&amp;16AMP SOCKETS 240V~ ( 2 Module )</b>				
102041	6&16A Universal Socket with safety shutter	325.00	358.00	10/450
102042A	6&16A Universal Power Socket with safety shutter  (Suggested to use with a partition plate)	357.00	394.00	10/450

Code	Item	MRP ₹		Pkg.
		White Jazz	Digital Chrome Voltage Grey	
<b>DIMMERS 240 V~50-60Hz 300-450W</b>				
101045	Dimmer (1M) 450W	356.00	391.00	20/600
102046	Dimmer (2M) 450W	463.00	511.00	10/300

Code	Item	MRP ₹		Pkg.
		White Jazz	Digital Chrome Voltage Grey	
<b>FAN REGULATOR 240V~</b>				
102049	8 Step Reg. - Full Rotary (2M) <b>NEW</b>	621.00	676.00	10/300
101050*	4 Step Regulator - Full Rotary (1M)	524.00	575.00	20/600
101051	4 Step Regulator (1M)	524.00	575.00	20/600
102052A	5 Step Regulator - Full Rotary (2M)	566.00	623.00	10/300
- Regulator Supplied in ISI & Non ISI				

Code	Item	MRP ₹		Pkg.
		White Jazz	Digital Chrome Voltage Grey	
<b>MOTOR STARTER (SP) 240V~ 50-60Hz ( 2 Module )</b>				
102059	25A Motor Starter Switch	745.00	819.00	10/300

Code	Item	MRP ₹		Pkg.
		White Jazz	Digital Chrome Voltage Grey	
<b>TV SOCKET / RJ-11 TELEPHONE JACK ( 1 Module )</b>				
101062	TV Socket Coaxial 40-862 Mhz Socket	177.00	194.00	20/900
101069	RJ-11 Single Telephone Jack	187.00	205.00	20/600

\* introducing shortly



Code	Item	MRP ₹		Pkg.
		White Jazz	Digital Chrome Voltage Grey	
<b>EDP SOCKET OUTLET RJ-45 WITH NAME PLATE ( 1 Module )</b>				
101072	EDP Socket Outlet - RJ 45 (Cat 5e) Category 5e, Universal wiring T568A, insulating-piercing terminal with shutter	271.00	297.00	20/600
101074	EDP Socket Outlet - RJ 45 (Cat 6e) Category 6e, Universal wiring T568A, insulating-piercing terminal with shutter	752.00	825.00	20/600
<b>SINGLE POLE MCBS 240/450V- ( 1 Module )</b>				
101077	C6 SP MCB	391.00	425.00	20/600
101078	C10 SP MCB	391.00	425.00	20/600
101079	C16 SP MCB	391.00	425.00	20/600
101080	C20 SP MCB	391.00	425.00	20/600
101081	C25 SP MCB	391.00	425.00	20/600
101082	C32 SP MCB 240/450V- 50-60Hz 3kA Breaking Capacity	391.00	425.00	20/600
<b>DOUBLE POLE MCBS 240/450V- ( 2 Module )</b>				
102083	C6 DP MCB	812.00	881.00	10/300
102084	C10 DP MCB	812.00	881.00	10/300
102085	C16 DP MCB	812.00	881.00	10/300
102086	C20 DP MCB	812.00	881.00	10/300
102087	C25 DP MCB	812.00	881.00	10/300
102088	C32 DP MCB 240/450V- 50-60Hz 3kA Breaking Capacity	812.00	881.00	10/300
<b>INDICATOR, FUSE UNITS ( 1 Module )</b>				
101093	Indicator with LED & Red Diffuser	147.00	164.00	20/600
101098	Fuse Carrier 10 / 16AMP with miniature fuse dia 6.3x28	207.00	228.00	20/600
<b>STEP MARKER LAMP ( 2 Module )</b>				
102105	Step Marker Supply voltage 240V- 50-60Hz with high-efficiency 1W LED & adjustable beam on three levels	649.00	713.00	5/120
<b>FLOOR &amp; STEP LIGHT 240V- ( 4 Module )</b>				
120405	G-Focus Light (Blue LED)	843.00	927.00	5/120
120405W	G-Focus Light (White LED)	843.00	927.00	5/120
120405WW	G-Focus Light (Warm White LED)	843.00	927.00	5/120
120406	G-Focus Light Trio (LED) Fully recessed floor & step light with support frame & glassio cover plate with 3 color inbuilt LED Supply voltage 240V-50-60Hz	921.00	1014.00	5/120

Code	Item	MRP ₹		Pkg.
		White Jazz	Digital Chrome Voltage Grey	
<b>LIGHTING FITTING WITH EMERGENCY FUNCTION 240V~</b>				
102119	Lighting Fitting with Emergency Function (2M) with High Efficiency 2x0.5W LED	1002.00	1081.00	5/100
<b>EMERGENCY LIGHT BATTERY</b>				
101123#	AAA Ni-MH 1.2V 1100 mAh without "memory" effect interchangeable - 3 Batteries set ( Spare parts )	412.00	-	N.A.
101124#	Battery Li-ion, 3.6V 600mAh 2/3A	270.00	-	20/600
<b>BLANK MODULE ( 1 Module )</b>				
101125	Blank Module	32.00	35.00	50/2000
<b>ELECTRONIC BUZZERS ( 2 Module )</b>				
102138	Electronic Cuckoo Buzzer 240V- 50-60Hz ( LED )	222.00	244.00	10/300
102139	Electronic Bell 240V- 50-60Hz ( LED )	380.00	419.00	10/300
<b>25A ELECTRONIC BADGE SWITCH ( 3 Module )</b>				
103165	Electronic Switch with Smart Card 25A, 160-240V- 50-60Hz with indicator (LED) & Integral relay having exit delay.	1834.00	2013.00	5/100
103166	Smart Card Customizable Smart Card	139.00	-	N.A.
<b>DND / MAKE MY ROOM ( 2 Module )</b>				
102168A#	Do Not Disturb/Make My Room 240V- 50-60Hz - Outside Room	497.00	545.00	10/300
102169A#	Do Not Disturb/Make My Room 240V- 50-60Hz - Inside Room	535.00	585.00	10/300
<b>SHAVER SOCKET ( 4 Module )</b>				
104171#	Shaver Socket 240V- 50-60Hz with isolating transformer output 110/240V-	1139.00	1253.00	5/50



# Products will be supplied from CENTRAL WAREHOUSE



Code	Item	MRP ₹		Pkg.
		White Jazz	Digital Chrome Voltage Grey	
<b>USB CHARGER 240V~</b>				
102170	65W C-Type Fast Charger - Single Port (2M) Supply voltage 160-240V~ 50-60Hz Output - PD USB Charger C type (Max 65W)	2200.00	2300.00	5/150
101172	USB Fast Charger - Single Port (1M) Supply voltage 160-240V~ 50-60Hz Output - 5V=1.50A / 9V=1.45A, A type (Max 14W)	1054.00	1158.00	10/300
102174	USB Charger - Double Port (2M) Supply voltage 160-240V~ 50-60Hz Output - 5V DC, 2000mA or 2A, A type	1019.00	1122.00	5/100
101175	18W C-Type Fast Charger - Single Port (1M) Supply voltage 160-240V~ 50-60Hz Output - 5V=2.5A / 9V=2A / 12V=1.5A USB Charger C type (Max 18W)	1469.00	1534.00	10/300
101176*	30W C-Type Fast Charger - Single Port (1M) Supply voltage 160-240V~ 50-60Hz Output - 5V=3A, 9V=3A, 12V=2.5A, 15V=2A, 20V=1.5A USB Charger C type (Max 30W)	1650.00	1750.00	10/300

<b>CRISTALLO SWITCH MEMORIO KNOB</b>				
101540	1 Module Switch Knob	12.00	-	50/2000
102541	2 Module Switch Knob	20.00	-	30/900
103542	3 Module Switch Knob (with support knob)	30.00	-	20/800

<b>SMART PASSIVE INFRARED DETECTOR ( 2 Module )</b>				
102212#	Smart Passive Infrared Detector with infrared sensor, auto on/off, adjustable dusk/dawn sensor threshold and time delay cycle, supply voltage 240V~ 50-60Hz, 6A relay output	2141.00	2353.00	5/120

<b>LPG / METANO GAS DETECTOR 240V~ ( 3 Module )</b>				
103225#	LPG / Metano Gas Detector Detector with acoustic and optical signaling and control on a solenoid valve, supply voltage 240V~50-60Hz	2859.00	3079.00	5/100

<b>RF REMOTE (RADIO FREQUENCY)</b>				
103268#	RF Remote with Stand 2 Nos AAA 1.5V Battery Radio Frequency : 433.92 Mhz All scene setting can be done through the Remote. - Battery not included	-	2199.00	-/100

\* introducing shortly  
# Products will be supplied from CENTRAL WAREHOUSE



Wega Tom & Jerry Plate with Titanium Grey Wi-Fi Router+Extender

Working from home calls for a reliable Wi-Fi network. Goldmedal's Wi-Fi Router + Extender is a smart solution for dead zone problems that many face. This unique device not only ensures uninterrupted and consistent Wi-Fi connectivity but can also extend the network signal to the remotest corners of your home. The device also has an inbuilt USB port for charging devices and Ethernet port for Internet connectivity. On the subject of charging, you should also consider the USB Charger & International Socket for getting your smart devices and electrical appliances charged. Along with charging your mobile devices, it also accepts different types of international plugs.



Wega Tom & Jerry Plate with Titanium Grey USB Charger & Inter. Socket



Code	Item	MRP ₹		
		White Jazz	Digital Chrome Voltage Grey	Outer/Master
<b>BLUETOOTH PLAYER ( 2 Module )</b>				
102273#	Bluetooth Player Supply voltage 240V- Bluetooth player with transmitter & receiver. Multicolour LED to display different status  Audio input - 3.5mm jack, Bluetooth (Rx mode)  Audio output - Can be connected to bluetooth speaker or headphones in Tx mode (Input - Aux in) - Can be connected to any music system, home audio system, speakers i.e ceiling or inwall through amplifier via Line out  Amplifier supplied separately - 101320	1243.00	1347.00	5/100
<b>BLUETOOTH &amp; FM PLAYER ( 8 Module )</b>				
108274#	Bluetooth & FM Player with Speaker Supply voltage 240V- Mode selection -Aux (Line 1), Aux (Line 2), FM & Bluetooth.  Audio input - 3.5 jack (Front), Line In (Back), Bluetooth  Audio output - Inbuilt Stereophonic Speaker 3W x 2 - Can be connected to any music system, home audio system, speakers i.e ceiling or inwall through amplifier via Line out  Amplifier supplied separately - 101320	5179.00	5697.00	5/50
<b>i - DOCK PLAYER ( 4 Module )</b>				
104281#	i-Dock Player Supply voltage 240V- Inbuilt stereo amplifier : 2 x 4W, charging function for iPod and iPhone. Audio input - 3.5mm jack, i-pod, i-phone & via Bluetooth Receiver (101283)  Audio output - Stereo Line out, 2 Speaker out 4W each - Can be connected to any music system, home audio system, speakers i.e ceiling or inwall through amplifier via Line out (Aux out)  - Amplifier supplied separately - 101320 - Bluetooth Receiver supplied separately - 101283  Unit supplied with infrared Remote	3212.00	3419.00	5/50
<b>BLUETOOTH RECEIVER ( PORTABLE )</b>				
101283#	Bluetooth Receiver ( Portable ) Made for iPod and iPhone docking Can be operated by any bluetooth device i.e. iPod, iPhone, iPad, Laptop, Mobile etc.	-	1140.00	5/50

Code	Item	MRP ₹		
		White Jazz	Digital Chrome Voltage Grey	Outer/Master
<b>STEREOPHONIC SPEAKER ( 2 Module )</b>				
102306#	Stereophonic Speaker - 2 piece set Stereophonic loud Speaker Load rating : 4W Impedance : 4 ohms	724.00	797.00	10/100
<b>CURVE MODULAR COVER PLATE SUITCASE</b>				
101645	Curve Cover Plate Suitcase	-	2100.00	1/5
<b>AUTOMATION SUITCASE</b>				
101649	Automation Suitcase Quorra Crystallight plate with Nixon WiFi inserts RF remote 6M WiFi panel	-	15000.00	1/5
<b>MODULAR COVER PLATE SUITCASE</b>				
101652*	Cover Plate Suitcase Includes Quorra Crystallight, Quorra Premium, Glassio, Wega etc. Cover Plates with Accessories / inserts	-	-	1/5
Regular Discounts are not applicable on Suitcases				
# Products will be supplied from CENTRAL WAREHOUSE				



# i-Touch WiFi Panels

Feather Touch IoT/RF Enabled Home Automation



TOUCH



TAP



SWIPE



Smart living made  
*smarter.*



i-World



IoT



Scene Setting



Timer



Remote

Presenting the next step in smart living. The i-Touch WiFi panels are the latest devices in Goldmedal's family of automation switches. Sleek and stylish in appearance, these backlit LED WiFi panels have a host of functions including switches, fan regulators, USB sockets, and international sockets. Apart from manual operations, you can also control these panels using the RF Remote control and voice commands. You can even operate these panels from anywhere in the world using the i-World mobile app. There's no gateway required - the technology is built into the device. A complete system by itself, the module can be installed directly into a regular junction without the need for any new wiring.



Code	Item	MRP ₹		Pkg.
		Absolute White	Digital Silver Titanium Grey	
<b>10AX SWITCHES 240V- ( 1 Module )</b>				
101401	1 Way Switch	91.00	98.00	20/600
101402	1 Way Switch with Indicator (LED)	161.00	178.00	20/600
101403	2 Way Switch	188.00	207.00	20/600
101404	Bell Push Switch	183.00	199.00	20/600
101405	Bell Push Switch with Indicator (LED)	193.00	211.00	20/600

Code	Item	MRP ₹		Pkg.
		Absolute White	Digital Silver Titanium Grey	
<b>10AX SWITCHES 240V- ( 2 Module )</b>				
102410	1 Way Switch	154.00	170.00	10/300
102411	1 Way Switch with Indicator (LED)	168.00	182.00	10/300
102412	2 Way Switch	240.00	263.00	10/300
102413	Bell Push Switch	248.00	272.00	10/300
102414	Bell Push Switch with Indicator (LED)	276.00	303.00	10/300
102415	Bell Push Switch with Luminous Name Plate	343.00	379.00	10/300

Code	Item	MRP ₹		Pkg.
		Absolute White	Digital Silver Titanium Grey	
<b>20AMP / 25AMP SWITCHES 240V- ( 1 Module )</b>				
101420	20A 1 Way Switch	245.00	270.00	20/600
101421	20A 1 Way Switch with Indicator	265.00	294.00	20/600
101422	20A 2 Way Switch	289.00	319.00	20/600
101423	25A 1 Way Switch	292.00	323.00	20/600

Code	Item	MRP ₹		Pkg.
		Absolute White	Digital Silver Titanium Grey	
<b>20AMP / 25AMP SWITCHES 240V- ( 2 Module )</b>				
102425	20A 1 Way Switch	271.00	296.00	10/300
102426	20A 1 Way Switch with Ind. (LED)	302.00	332.00	10/300
102427	20A 2 Way Switch	342.00	378.00	10/300
102428	25A 1 Way Switch	344.00	379.00	10/300

Code	Item	MRP ₹		Pkg.
		Absolute White	Digital Silver Titanium Grey	
<b>32AMP DP SWITCH 240V- ( 2 Module )</b>				
102431	32A DP Switch with Indicator (LED)	504.00	557.00	10/300

240V- 50-60Hz LED circuit with diffuser

Code	Item	MRP ₹		Pkg.
		Absolute White	Digital Silver Titanium Grey	
<b>G-Click 10AX SWITCHES 240V- ( 1 Module )</b>				
101751	1 Way Switch	98.00	107.00	20/600
101752	1 Way Switch with Indicator (LED)	168.00	187.00	20/600
101753	2 Way Switch	192.00	212.00	20/600
101754	Bell Push Switch	190.00	208.00	20/600
101755	Bell Push Switch with Indicator (LED)	203.00	223.00	20/600

Code	Item	MRP ₹		Pkg.
		Absolute White	Digital Silver Titanium Grey	
<b>G-Click 10AX SWITCHES 240V- ( 2 Module )</b>				
102760	1 Way Switch	163.00	180.00	10/300
102761	1 Way Switch with Indicator (LED)	176.00	192.00	10/300
102762	2 Way Switch	251.00	275.00	10/300
102764	Bell Push Switch with Indicator (LED)	287.00	315.00	10/300

Code	Item	MRP ₹		Pkg.
		Absolute White	Digital Silver Titanium Grey	
<b>G-Click 20AMP / 25AMP SWITCHES 240V- ( 1 Module )</b>				
101770	20A 1 Way Switch	255.00	281.00	20/600
101771	20A 1 Way Switch with Indicator	268.00	294.00	20/600
101772	20A 2 Way Switch	290.00	319.00	20/600
101773	25A 1 Way Switch	306.00	337.00	20/600

Code	Item	MRP ₹		Pkg.
		Absolute White	Digital Silver Titanium Grey	
<b>G-Click 20AMP / 25AMP SWITCHES 240V- ( 2 Module )</b>				
102775	20A 1 Way Switch	283.00	312.00	10/300
102776	20A 1 Way Switch with Ind. (LED)	314.00	346.00	10/300
102777	20A 2 Way Switch	359.00	394.00	10/300
102778	25A 1 Way Switch	362.00	398.00	10/300

Code	Item	MRP ₹		Pkg.
		Absolute White	Digital Silver Titanium Grey	
<b>G-Click 32AMP DP SWITCH 240V- ( 2 Module )</b>				
102781	32A DP Switch with Indicator (LED)	528.00	582.00	10/300





Code	Item	MRP ₹		Pkg.
		Absolute White	Digital Silver Titanium Grey	
<b>G-Dip 10AX SWITCHES 240V~ ( 1 Module )</b>				
101801	1 Way Switch	91.00	98.00	20/600
101802	1 Way Switch with Indicator (LED)	161.00	178.00	20/600
101803	2 Way Switch	188.00	207.00	20/600
101804	Bell Push Switch	183.00	199.00	20/600
101805	Bell Push Switch with Indicator (LED)	193.00	211.00	20/600

Code	Item	MRP ₹		Pkg.
		Absolute White	Digital Silver Titanium Grey	
<b>G-Dip 10AX SWITCHES 240V~ ( 2 Module )</b>				
102810	1 Way Switch	154.00	170.00	10/300
102811	1 Way Switch with Indicator (LED)	168.00	182.00	10/300
102812	2 Way Switch	240.00	263.00	10/300
102813	Bell Push Switch	248.00	272.00	10/300
102814	Bell Push Switch with Indicator (LED)	276.00	303.00	10/300

Code	Item	MRP ₹		Pkg.
		Absolute White	Digital Silver Titanium Grey	
<b>G-Dip 20AMP / 25AMP SWITCHES 240V~ ( 1 Module )</b>				
101820	20A 1 Way Switch	245.00	270.00	20/600
101821	20A 1 Way Switch with Indicator	265.00	294.00	20/600
101822	20A 2 Way Switch	289.00	319.00	20/600
101823	25A 1 Way Switch	292.00	323.00	20/600

Code	Item	MRP ₹		Pkg.
		Absolute White	Digital Silver Titanium Grey	
<b>G-Dip 20AMP / 25AMP SWITCHES 240V~ ( 2 Module )</b>				
102825	20A 1 Way Switch	271.00	296.00	10/300
102826	20A 1 Way Switch with Ind. (LED)	302.00	332.00	10/300
102827	20A 2 Way Switch	342.00	378.00	10/300
102828	25A 1 Way Switch	344.00	379.00	10/300

Code	Item	MRP ₹		Pkg.
		Absolute White	Digital Silver Titanium Grey	
<b>G-Dip 32AMP DP SWITCHES 240V~ ( 2 Module )</b>				
102831	32A DP Switch with Indicator (LED)	504.00	557.00	10/300

Code	Item	MRP ₹		Pkg.
		Absolute White	Digital Silver Titanium Grey	
<b>32AMP NANO DP SWITCH 240V~ ( 2 Module )</b>				
102432	32A Nano DP Switch with Indicator (LED)	554.00	613.00	10/300

Code	Item	MRP ₹		Pkg.
		Absolute White	Digital Silver Titanium Grey	
<b>6AMP SOCKETS 240V~</b>				
102438	6A 3 Pin Socket ( 2M ) with safety shutter	171.00	187.00	10/450

Code	Item	MRP ₹		Pkg.
		Absolute White	Digital Silver Titanium Grey	
<b>6&amp;16AMP SOCKETS 240V~ ( 2 Module )</b>				
102441	6&16A Universal Socket with safety shutter	341.00	376.00	10/450
102442A	6&16A Universal Power Socket with safety shutter	368.00	404.00	10/450
	(Suggested to use with a partition plate)			

Code	Item	MRP ₹		Pkg.
		Absolute White	Digital Silver Titanium Grey	
<b>6 &amp; 16AMP SOCKET WITH FLAP - ( 2 Module )</b>				
102444	6&16A Universal Socket with flap & Indicator - 240V~	330.00	363.00	10/450

Code	Item	MRP ₹		Pkg.
		Absolute White	Digital Silver Titanium Grey	
<b>DIMMER / FAN REGULATOR 240 V~</b>				
101445	Dimmer - 450W ( 1M )	394.00	432.00	20/600
102449	8 Step Regulator ( 2M )	671.00	731.00	10/300
101450*	4 Step Regulator - Full Rotary ( 1M )	578.00	636.00	20/600
101451	4 Step Regulator ( 1M )	578.00	636.00	20/600
102452	5 Step Regulator ( 2M )	616.00	676.00	10/300
	- Regulator Supplied with ISI & Non ISI			

Code	Item	MRP ₹		Pkg.
		Absolute White	Digital Silver Titanium Grey	
<b>FAN REGULATOR 240V~ ( 2 Module )</b>				
102453	5 Step Galaxy Step Regulator Half Rotary (Pure White)	568.00	-	10/300
102454	5 Step Galaxy Step Regulator Full Rotary (Pure White)	616.00	-	10/300
	- Regulator Supplied with ISI & Non ISI			

Code	Item	MRP ₹		Pkg.
		Absolute White	Digital Silver Titanium Grey	
<b>FAN REGULATOR 240V~ ( 2 Module )</b>				
102453A	5 Step Galaxy Step Regulator Half Rotary (Chrome Knob)	594.00	653.00	10/300
102454A	5 Step Galaxy Step Regulator Full Rotary (Chrome Knob)	644.00	708.00	10/300
	- Regulator Supplied with ISI & Non ISI			
	* introducing shortly			

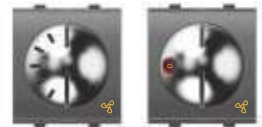
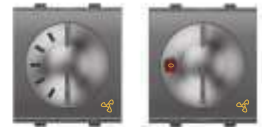
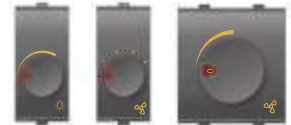
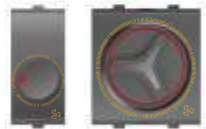



Code	Item	MRP ₹		Pkg.
		Absolute White	Digital Silver Titanium Grey	

**MOTOR STARTER (SP) 240V~ 50-60Hz [ 2 Module ]**

102459	25A Motor Starter Switch	782.00	860.00	10/300
--------	--------------------------	--------	--------	--------

**TV SOCKET / RJ-11 TELEPHONE JACKS / EDP SOCKET ( 1 Module )**

101462	TV Socket Coaxial 40-862 MHz Socket	180.00	194.00	20/900
101468	Telephone Jack - RJ 11	188.00	207.00	20/600
101472	EDP Socket Outlet - RJ 45 [Cat 5e] Category 5e, Universal wiring T568A, insulating-piercing terminal	307.00	338.00	20/600
101474	EDP Socket Outlet - RJ 45 [Cat 6e] Category 6e, Universal wiring T568A, insulating-piercing terminal	781.00	859.00	20/600

**SINGLE POLE MCBs 240/450V~ ( 1 Module )**

101477	C6 SP MCB	414.00	456.00	20/600
101478	C10 SP MCB	414.00	456.00	20/600
101479	C16 SP MCB	414.00	456.00	20/600
101480	C20 SP MCB	414.00	456.00	20/600
101481	C25 SP MCB	414.00	456.00	20/600
101482	C32 SP MCB	414.00	456.00	20/600

240/450V~ 50-60Hz 3kA Breaking Capacity

**DOUBLE POLE MCBs 240/450V~ ( 2 Module )**

102483	C6 DP MCB	813.00	893.00	10/300
102484	C10 DP MCB	813.00	893.00	10/300
102485	C16 DP MCB	813.00	893.00	10/300
102486	C20 DP MCB	813.00	893.00	10/300
102487	C25 DP MCB	813.00	893.00	10/300
102488	C32 DP MCB	813.00	893.00	10/300

240/450V~ 50-60Hz 3kA Breaking Capacity

**G-POWER 16A UNIT [ 4 Module ]**

104491A	G-Power 16A AC (Metal Box) Heavy Duty with Concealed Metal Junction Box (4M Plate with 25A MCB, 16A Socket & 16A G-grip Top)	913.00	1010.00	5/60
104492A	G-Power 16A AC (Plastic Box) Heavy Duty with G-surface Plastic Gang Box (4M Plate with 25A MCB, 16A Socket & 16A G-grip Top)	880.00	967.00	5/60

240V~ 50-60Hz 3kA Breaking Capacity

**INDICATOR / FUSE UNIT / BLANK MODULE ( 1 Module )**

101493	Indicator with LED & Red Diffuser	153.00	169.00	20/600
101495	Indicator with LED & Red Diffuser (PCB)	153.00	169.00	20/600
101498	Fuse Carrier (10Amp/16Amp) with miniature fuse dia 6.3x28	204.00	223.00	20/600
101525	Blank Module	34.00	36.00	50/2000

Code	Item	MRP ₹		Pkg.
		Absolute White	Digital Silver Titanium Grey	

**STEP MARKER**

102505	Step Marker (2M) with High Efficiency 2x0.5W LED	660.00	726.00	5/120
103506	Step Marker with Step Dimming Function (3M) with High Efficiency 3x0.5W LED	1215.00	1336.00	5/100
102507	Step Marker with Smart Dimming Function (2M) with High Efficiency 2x0.5W LED	919.00	1009.00	5/100
103508	Step Marker with Trio LED & Step Dimming Function (3M) with High Efficiency 3x0.5W LED Supply voltage 240V~ 50-60Hz,	1215.00	1336.00	5/100

**LIGHTING FITTING WITH EMERGENCY FUNCTION**

102510	Lighting Fitting with Emergency Function (2M) with High Efficiency 2x0.5W LED	983.00	1061.00	5/100
103511	Lighting Fitting with Emergency Function (3M) with High Efficiency 3x0.5W LED Supply voltage 160-240V~ 50Hz Dimmable function (3 Level) The device will function as an emergency light if battery is inserted - Battery supplied separately (101123 for 3M / 101124 for 2M)	1550.00	1707.00	5/100

**ELECTRO MECHANICAL BUZZER / ELECTRONIC BUZZER 240V ~**

101530	Electro Mechanical Buzzer (1M) 240V~50-60Hz	194.00	213.00	20/600
102539	Electronic Bell (2M) 240V~50-60Hz	440.00	483.00	10/300

**ELECTRONIC DOOR BELLS ( 4 Module )**

104541#	Electronic Multi Tune Bell with 4 selectable melodies Supply voltage 240V~ 50-60Hz,	1125.00	1251.00	5/150
---------	--	---------	---------	-------

**i-TOUCH RF SWITCHES / UNIVERSAL SWITCH ( 2 Module )**

102544#	i-Touch 2 Switch Supply voltage 160-240V~, 6A relay output Operating load (CFL & LED): 100W Max (per switch) Radio Frequency : 433.92 Mhz Can also be operated by RF Remote control-103268 or web/mobile application via Gateway-101646	3626.00	4040.00	5/100
102545#	i-Touch Universal Switch Supply voltage 240V~, - Can be paired wirelessly with any Goldmedal RF switch, fan regulator, dimmer etc. (Touch, i-Touch and i-Feel) as a two way switch - Can be configured as a switch for any particular scene or All ON or All OFF command	4040.00	4455.00	5/100

**i-TOUCH BELL PUSH / RF 20A SWITCH ( 2 Module )**

102548#	i-Touch Bell Push Switch Supply voltage 160-240V~ 2A relay output	2383.00	2590.00	5/100
102550#	i-Touch 20A Switch Supply voltage 160-240V~, 20A relay output Operating load (CFL & LED): 200W Max Air conditioner: 2 ton Radio Frequency : 433.92 Mhz Can also be operated by RF Remote control-103268 or web/mobile application via Gateway-101646	3730.00	4144.00	5/100

# Products will be supplied from CENTRAL WAREHOUSE





Code	Item	MRP ₹		Pkg.
		Absolute White	Digital Silver Titanium Grey	
<b>i-TOUCH RF DIMMER/FAN REGULATOR/DRAPE CONTROLLER ( 2M )</b>				
102553#	<b>i-Touch Light Dimmer</b> Supply voltage 160-240V~, Triac Technology with soft end & soft start function Operating load (LED) : 80W (Max) Incandescent Light: 40-450W <b>Not suitable for Fan</b>	3626.00	3937.00	5/100
102554#	<b>i-Touch Fan Regulator</b> Supply voltage 160-240V~ Variable Capacitance based 4 step regulator Operating load (Fan) : 100W	3626.00	3937.00	5/100
102556#	<b>i-Touch Drape Controller</b> Supply voltage 160-240V~ 2.5A relay output Electronic RF Drape Controller suitable for AC Motor  Radio Frequency : 433.92 Mhz Can also be operated by RF Remote control-103268 or web/mobile application via Gateway-101646	3937.00	4351.00	5/100

<b>i-TOUCH DO NOT DISTURB/MAKE MY ROOM ( 2 Module )</b>				
102560#	<b>i-Touch DND / Make My Room / Please Wait (Inside Room)</b>	2176.00	2590.00	5/100
102561#	<b>i-Touch DND / Make My Room / Please Wait with Bell Push Switch (Outside Room)</b>  Supply voltage 160-240V~ (Inside & outside unit are connected to each other)	2383.00	2797.00	5/100

<b>32A MAIN SWITCH ( 3 Module )</b>				
103562	<b>32A DP Operated by Key Tag 240V~, LED</b> Supplied with Key Tag For key tag please refer Curve product 102164	592.00	650.00	5/150

<b>32A MAIN SWITCH ( 2 Module )</b>				
102563	<b>32A DP Operated by Key Tag 240V~, LED</b> Supplied with Key Tag	729.00	803.00	10/300
102564	<b>Only Key Tag with Name Plate</b>	125.00	136.00	N.A.

<b>25A ELECTRONIC BADGE SWITCH ( 3 Module )</b>				
103565	<b>Electronic Switch with Smart Card 25A, 160-240V~ 50-60Hz</b> with indicator (LED) & Integral relay having exit delay. For smart card please refer Curve product 103166	1865.00	2047.00	5/100

<b>BELL INDICATOR ( 6 Module ) 240~</b>				
106567	<b>Bell Indicator with 6 Display Units with buzzer, reset switches &amp; name plate</b>  Supply voltage 160-240V~ 50/60Hz	1823.00	2038.00	5/100

Code	Item	MRP ₹		Pkg.
		Absolute White	Digital Silver Titanium Grey	
<b>DND/MAKE MY ROOM 240~ ( 2 Module )</b>				
102568#	<b>Do Not Disturb/Make My Room 240V~ 50-60Hz - Inside Room</b>	517.00	564.00	10/300
102569#	<b>Do Not Disturb/Make My Room 240V~ 50-60Hz - Outside Room</b>	552.00	599.00	10/300

<b>USB CHARGER 240~</b>				
102570	<b>65W C-Type Fast Charger - Single Port (2M)</b> Supply voltage 160-240V~ 50-60Hz Output - PD USB Charger C type (Max 65W)	2200.00	2300.00	5/150
101571	<b>USB Fast Charger - Single Port (1M)</b> Supply voltage 160-240V~ 50-60Hz Output - 5V=1.50A / 9V=1.45A, A type (Max 14W)	1034.00	1136.00	10/300
102573	<b>USB Charger - Double Port (2M)</b> Supply voltage 160-240V~ 50-60Hz Output - 5V DC, 2A, A type (Total)	1001.00	1101.00	5/100
103574#	<b>USB Charger &amp; 10A Int. Socket (3M)</b> Supply voltage 160-240V~ 50-60Hz Output - 5V DC, 2A, A type (Total)	1357.00	1491.00	5/100
101575	<b>18W C-Type Fast Charger - Single Port (1M)</b> Supply voltage 160-240V~ 50-60Hz Output - 5V=2.5A / 9V=2A / 12V=1.5A USB Charger C type (Max 18W)	1469.00	1534.00	10/300
101576*	<b>30W C-Type Fast Charger - Single Port (1M)</b> Supply voltage 160-240V~ 50-60Hz Output - 5V=3A, 9V=3A, 12V=2.5A, 15V=2A, 20V=1.5A USB Charger C type (Max 30W)	1650.00	1750.00	10/300

<b>AUDIO - VIDEO SOCKET ( 1 Module )</b>				
101577#	<b>HDMI Socket</b>	1088.00	1199.00	5/150

<b>ROUTER + EXTENDER ( 3 Module )</b>				
103580#	<b>Wi-Fi Router + Extender</b> 300 MBPS wi-fi wireless router with Ethernet port, In-built USB port for internet connectivity and charging devices. Also support 4G dongle.	4662.00	5180.00	5/100

<b>CAMERA / IP CAMERA</b>				
102598*	<b>Camera (2M)</b> Automatic day/night switching, Camera can be manually swivelled 20° horizontally & vertically Automatic background lighting compensation. Automatic gain control (AGC) Protection type IP 44	-	9789.00	5/100
103599*	<b>IP Camera (3M)</b> Automatic day/night switching, Camera can be manually swivelled 20° horizontally & vertically Automatic background lighting compensation. Automatic gain control (AGC) Supply voltage 160-240V~	-	14918.00	5/100

<b>i-SENSE SENSO SWITCH ( 2 Module )</b>				
102601#	<b>i-Sense Senso Switch</b> Supply voltage 160-240V~ 6A relay output Allows to control lights by simply passing the hand in front of it (Max distance 50mm). 2 units can be combined to control the same light (2 way function).  * introducing shortly  # Products will be supplied from CENTRAL WAREHOUSE	3100.00	3400.00	5/100





Code	Item	MRP ₹		Pkg.
		Absolute White	Digital Silver Titanium Grey	
<b>i-SENSE FM RADIO / BLUETOOTH PLAYER</b>				
102603#	i-Sense FM Radio [2M] Feather touch FM radio with digital display 87-50 MHZ, 30 Station Memory with scanner	-	6320.00	5/100
103604#	i-Sense FM Radio / Bluetooth [3M] FM & Bluetooth player Mode selection : FM & Bluetooth. Audio output - Stereo Line out - Can be connected to any music system, home audio system, speakers i.e ceiling or inwall through amplifier via Line out, Supply voltage 240V- - Amplifier supplied separately - 101320	2590.00	-	5/100
<b>i-FEEL RF SWITCHES / BELL PUSH SWITCH [ 2 Module ]</b>				
102626#	i-Feel 2 Switch Supply voltage 160-240V-, 6A relay output Operating load (CFL & LED): 100W Max (per switch) Radio Frequency : 433.92 Mhz - Can also be operated by RF Remote control-103268 or web/mobile application via Gateway-101646	3626.00	3989.00	5/100
102630#	i-Feel Bell Push Switch Supply voltage 160-240V-- 2A relay output	2072.00	2279.00	5/100
<b>i-FEEL RF 20A SWITCH ( 2 Module )</b>				
102632#	i-Feel 20A Switch Supply voltage 160-240V-, 20A relay output Operating load (CFL & LED): 200W Max Air Conditioner: 2 ton Radio Frequency : 433.92 Mhz  Can also be operated by RF Remote control-103268 or web/mobile application via Gateway-101646	3833.00	4217.00	5/100
<b>i-FEEL RF DIMMER / FAN REGULATOR ( 2 Module )</b>				
102634#	i-Feel Light Dimmer Supply voltage 160-240V-, Triac Technology with soft end & soft start function Operating load LED: 80W Incandescent Light: 40-450W Not suitable for Fan	3626.00	3989.00	5/100
102636#	i-Feel Fan Regulator Supply voltage 160-240V-- Variable Capacitance based 4 step regulator Operating load (Fan) : 100W Radio Frequency: 433.92 Mhz  Can also be operated by RF Remote control-103268 or web/mobile application via Gateway-101646	3626.00	3989.00	5/100
<b>i-FEEL RF DRAPE CONTROLLER ( 2 Module )</b>				
102638#	i-Feel Drape Controller Supply voltage 160-240V-- 2.5A relay output Electronic RF Drape Controller suitable for AC Motor Radio Frequency : 433.92 Mhz  Can also be operated by RF Remote control-103268 or web/mobile application via Gateway-101646	3730.00	4103.00	5/100

# Products will be supplied from CENTRAL WAREHOUSE

Code	Item	MRP ₹		Pkg.
		Absolute White	Digital Silver Titanium Grey	
<b>i-REMOTE CONTROL / ENOCEAN SWITCH</b>				
101926#	i-Remote with Micro USB Cable Wifi-IR Remote Control Universal Infrared Remote Control Can operate TV, Set Top Box, AC and other IR Remotes Works with WiFi through World App or Voice Command (Google Home / Amazon Alexa)	-	3107.00	1/1
ENS0001##	Enoclean Switch - 2M <b>NEW</b> 4 Button Controller for G-mesh (BLE)	9000.00	9750.00	1/1
<b>i-TOUCH WI-FI 6A &amp; 20A SWITCH ( 2 Module )</b>				
102901#	i-Touch - Wi-Fi 2 Switch Supply voltage 160-240V-, 6A relay output Operating load (CFL & LED): 100W Max (per switch) Radio Frequency : 433.92 Mhz	5100.00	5600.00	5/100
102903#	i-Touch - Wi-Fi 20A Switch Supply voltage 160-240V-, 20A relay output Operating load (CFL & LED): 200W Max Air conditioner: 2 ton Radio Frequency : 433.92 Mhz  Can also be operated by RF Remote control-103268 or via Wi-Fi Internet (without Gateway)	5100.00	5600.00	5/100
<b>i-TOUCH WI-FI DIMMER/FAN REGULATOR ( 2 Module )</b>				
102906#	i-Touch Wi-Fi Dimmer Supply voltage 160-240V-, Triac Technology with soft end & soft start function Operating load (LED) : 80W (Max) Incandescent Light: 40-450W Not suitable for Fan	5100.00	5600.00	5/100
102907#	i-Touch Wi-Fi Fan Regulator Supply voltage 160-240V-- Variable Capacitance based 4 step regulator Operating load (Fan) : 100W  Radio Frequency : 433.92 Mhz Can also be operated by RF Remote control-103268 or via Wi-Fi Internet (without Gateway)	5100.00	5600.00	5/100
<b>i-TOUCH WI-FI DRAPE CONTROLLER ( 2 Module )</b>				
102909#	i-Touch Wi-Fi Drape Controller Supply voltage 160-240V-- 2.5A relay output Electronic RF Drape Controller suitable for AC Motor Radio Frequency : 433.92 Mhz  Can also be operated by RF Remote control-103268 or via Wi-Fi Internet (without Gateway)	5100.00	5600.00	5/100
<b>i-TOUCH WI-FI SWITCH ( 3 Module )</b>				
103913#	i-Touch - Wi-Fi 4 Switch with Master Supply voltage 160-240V-, 6A relay output Operating load (CFL & LED): 100W Max (per switch) Radio Frequency : 433.92 Mhz	7500.00	8250.00	5/100
103916#	i-Touch - Wi-Fi 2 Switch + 1 Fan Regulator with Master Supply voltage 160-240V-, 6A relay output Operating load (CFL & LED): 100W Max (per switch) Radio Frequency : 433.92 Mhz  Can also be operated by RF Remote control-103268 or via Wi-Fi Internet (without Gateway)	8600.00	9500.00	5/100

## Please refer KNX Catalog

# Products will be supplied from CENTRAL WAREHOUSE



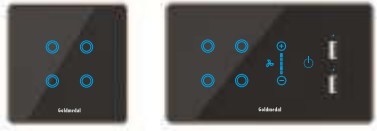

Code	Item	MRP ₹		Pkg.
		Absolute White	Digital Silver Titanium Grey	
<b>i-TOUCH WI-FI PANEL 240V~ [ 2 &amp; 4 Module ]</b>				
102920#	i-Touch - Wi-Fi 4 Switch (With Glass Plate) Supply voltage 160-240V~, 6A relay output Operating load (CFL & LED): 100W Max (per switch) Radio Frequency : 433.92 MHZ	-	7850.00	5/-
104924#	i-Touch - WiFi 4 Switch + Fan Reg. + 2 USB Port (With Glass Plate) Supply voltage 160-240V~, 6A relay output Operating load (CFL & LED): 100W Max (per switch) Radio Frequency : 433.92 MHz Variable Capacitance based 5 Step Fan Regulator USB Output: 5V 2A DC (Max) Can also be operated by RF Remote control-103268 or via Wi-Fi Internet (without Gateway) through i-World Mobile App.	-	11900.00	5/-
<b>i-TOUCH WI-FI PANEL 240V~ [ 6 Module ]</b>				
106925#	i-Touch - WiFi 6 Switch + Fan Reg. + 2 USB Port + Int. Socket (With Glass Plate) Supply voltage 160-240V~, 6A relay output Operating load (CFL & LED): 100W Max (per switch) Radio Frequency : 433.92 MHz Variable Capacitance based 5 Step Fan Regulator USB Output: 5V 2A DC (Max) Socket: 10A International Socket Can also be operated by RF Remote control-103268 or via Wi-Fi Internet (without Gateway) through i-World Mobile App.	-	14850.00	5/-
<b>STEP MARKER 240V- 50-60Hz - [ 3 Module ]</b>				
103648	Step Marker (LED) Supply voltage 240V- 50-60Hz	604.00	678.00	5/100
<b>IN-WALL CONTROLLER</b>				
101931*	Smart Switch - 3 Node Supply voltage: 160-240 VAC, 50Hz, 6A relay output Operating Load (CFL&LED): 100W (per switch) Wi-Fi Frequency: 2.4GHz  Can also be operated by Wi-Fi internet (Without Gateway) through G-World Mobile App.	1999.00	-	10/-

\* introducing shortly

# Products will be supplied from CENTRAL WAREHOUSE

# i-WORLD Automation

Goldmedal presents the i-World app. The easiest, most convenient way to monitor, control, and customize all your electrical devices that are part of the i-Touch/i-Smart Wi-Fi ecosystem.

You can not only control devices, but also share this control with others by creating multiple users and setting up different usage rights. So, share control with your family, or restrict usage of certain rooms or devices with other users, or categorize devices by room, or assign administrator rights to someone – the possibilities are simply immense.

The i-World app can also be integrated with Amazon Alexa and Google Home Assistant. Just speak out your wish and the i-World app will do as you command!

Switch to a smarter lifestyle with smart switches from Goldmedal.

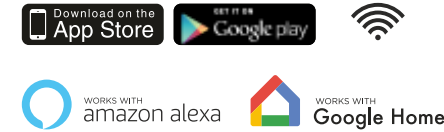

## Goldmedal i-World

Download the Goldmedal i-World App on your smart device to control your i-Touch & i-Smart WiFi Switches from anywhere in the world. Download now!



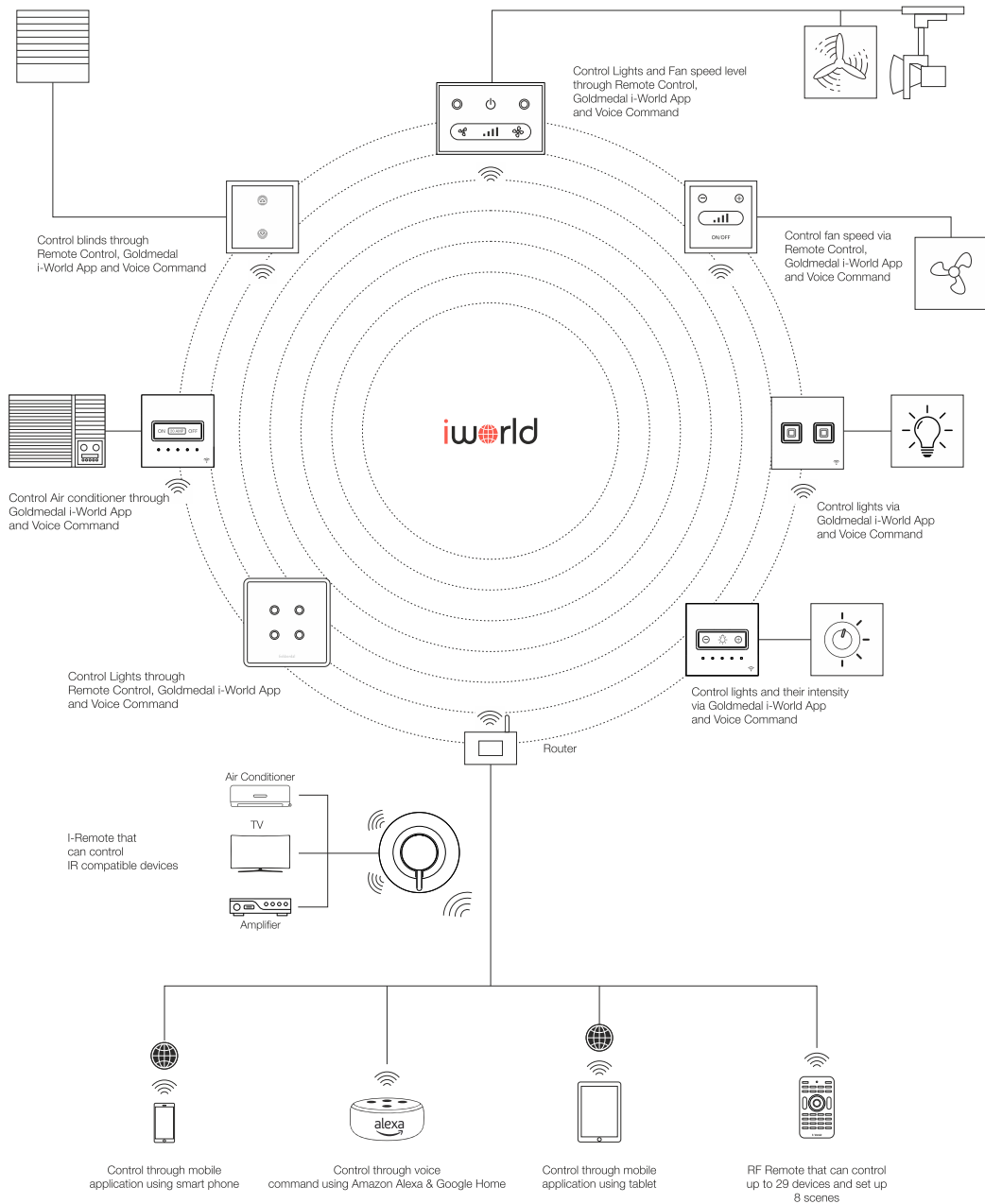

## i-TOUCH WI-FI / i-SMART WI-FI / i-TOUCH WI-FI PANEL

Installing i-Touch Wi-Fi/i-Smart Wi-Fi/i-Touch Wi-Fi panel does not require any drilling or additional wiring. Simply plug them into your existing wiring and it's done. These switches and panels are designed with Switched Mode Power Supply (SMPS) for improved reliability, over-current, and over-voltage protection. (For specific installation and technical details, please refer to the technical sheet provided within the product packaging).

### i-Touch Wi-Fi 4 Switch with Master (Wiring Diagram)

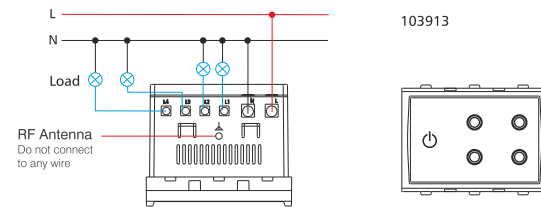

#### Technical Specifications

- Rated Voltage: 160-240V~ 50-60Hz
- Rated Load per Switch :
  - a) Capacitive Load - CFL & LED (PF>0.8) : 100W
  - b) Resistive Load - Incandescent & Halogen Lights: 1000 W
  - c) Inductive Load - Fan and Motor : 800W
- Service Life: 50,000 Operations

### i-Touch Wi-Fi 2 Switch + 1 Fan Regulator with Master (Wiring Diagram)

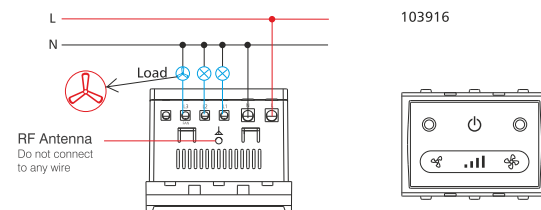

#### Technical Specifications

- Rated Voltage: 160-240V~ 50Hz
- Rated Load per switch:
  - a) Capacitive Load - CFL & LED (PF>0.8) : 100W
  - b) Resistive Load - Incandescent & Halogen Lights: 1000 W
  - c) Inductive Load - Fan and Motor - 800 W
- Rated Load: Fan Regulator - Max 100 W
- 4-Level Speed Selection with Indicator
- Service Life: 50,000 Operations

### i-Smart Fan Regulator (Wiring Diagram)

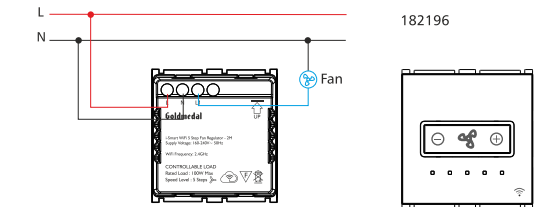

#### Controllable Load:

- Rated Voltage : 160-240V – 50Hz
- Rated load : 100W Max
- Speed Level – 5 Steps

### i-Touch Wi-Fi 4 Switch + Fan Regulator + 2 USB Port (With Glass Plate) (Wiring Diagram)

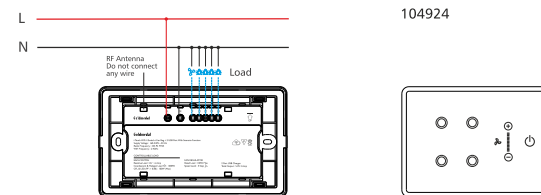

#### Technical Specifications

- Rated Voltage: 160-240V~ 50Hz
- Rated output (USB): 5.0V DC, 2000mA (max)
- Rated Load per switch:
  - a) Capacitive Load - CFL & LED (PF>0.8) : 100W
  - b) Resistive Load - Incandescent & Halogen Lights: 1000 W
  - c) Inductive Load - Fan and Motor - 800 W
- Rated Load: Fan Regulator - Max 100 W
- 5-Level Speed Selection with Indicator
- Service Life: 50,000 Operations

Wire colour codes: ■ Red (live),  
■ Black (neutral),  
■ Blue (load).



The circle of power and style.



Boomeroo  
Pop-Up Multi Socket Cabinet  
(Concealed - Table Mounted)

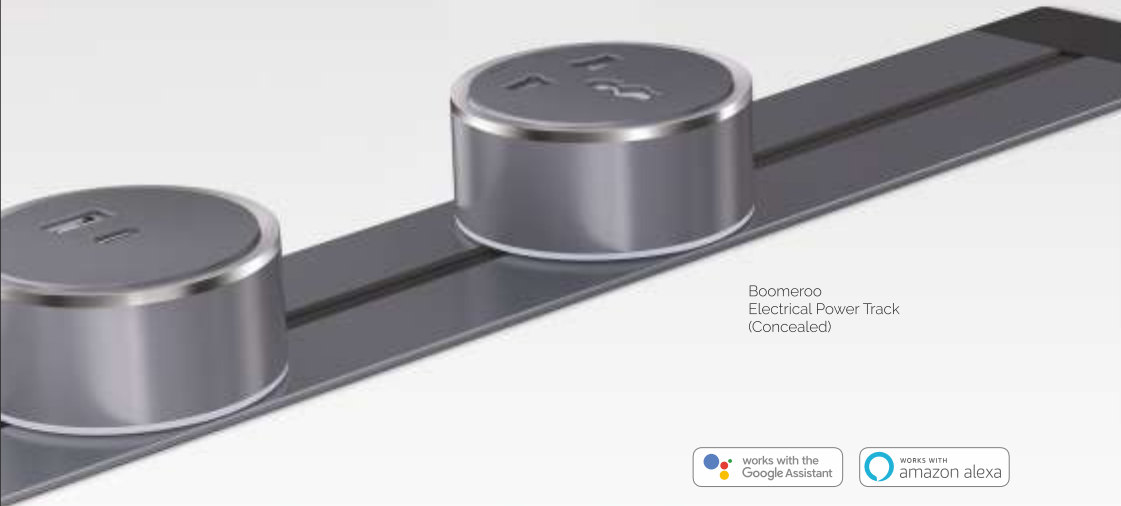

Boomeroo  
Electrical Power Track  
(Concealed)



The Boomeroo multiplug, smart pop-up socket revolutionizes workspace connectivity by integrating features such as a wireless charger, Bluetooth speaker, USB socket, and inductive touch switch. Meanwhile, the Boomeroo power track and movable sockets offer unparalleled flexibility that allows you to power or charge your devices conveniently. Both devices are perfect for enhancing functionality and convenience across various settings such as office tables, meeting tables, insular shelves, bar counters, kitchen worktops, desks, and exhibition rooms. They offer a seamless blend of technology and design, catering to the modern, dynamic workspace.

Code	Item	MRP ₹	Pkg.
<b>NEW</b>			
<b>BOOMEROO ELECTRICAL POWER TRACK CONCEALED</b>			
105001#	Boomeroo Power Track 60cm Size: 8x1.9x60 (WxHxL)	- 7000.00	1/20
105002#	Boomeroo Power Track 100cm Size: 8x1.9x100 (WxHxL)	- 9000.00	1/15
105003#	Boomeroo Power Track 150cm Size: 8x1.9x150 (WxHxL)	- 13500.00	1/08
Supply Voltage : 110 -250V- 50Hz Rated Current: 32A Rated Power:8000W (Max) -IP 20, Aluminum alloy, Integrated copper bar with safety shutter (Above size mentioned is in CM)			
<b>NEW</b>			
<b>BOOMEROO ELECTRICAL POWER TRACK SURFACE WITH LED</b>			
105006#	Boomeroo Power Track 50cm Size: 8.6x1.9x50 (WxHxL)	- 12000.00	1/20
105007#	Boomeroo Power Track 80cm Size: 8.6x1.9x80 (WxHxL)	- 14000.00	1/15
Supply Voltage : 110 -250V AC 50Hz Rated Current: 32A Rated Power: 8000W (Max) Light Output: 8W (6500K) -IP 20, Aluminum alloy, Integrated copper bar with safety shutter (Above size mentioned is in CM)			
<b>NEW</b>			
<b>BOOMEROO TABLE MOUNTED TRACK SOCKET</b>			
105011#	Boomeroo Universal Socket Socket: 10A Universal Socket	- 1000.00	1/120
105012#	Boomeroo USB Charger A & C Type USB Output: 5V=2.4A	- 2400.00	1/120
<b>NEW</b>			
<b>BOOMEROO POP-UP MULTI SOCKET CABINET</b>			
105021#	Boomeroo Pop-Up Multi Socket Cabinet (Concealed-Table Mounted) Supply Voltage : 220-240V - 50Hz USB Type-A Output: 5V=2.1A USB Type-C Output : 5V=2.1A/9V=2.25A/12V=1.66A Wireless Charging: 15W(Max) Socket : 13A Universal Socket Soft Touch based lifting function FM, Bluetooth Player, USB & Recording Mode Audio Output: Stereophonic Speaker 3W Opening Size: 95mm (Circle hole of table) Can also be operated by Goldmedal i-World app and supports voice assistants Google and Alexa.	- 44499.00	1/20

# Products will be supplied from CENTRAL WAREHOUSE





Bella White Jazz Plate with Curve White Jazz Switches

# bella

You are mesmerized by the smile of a newborn; you wonder at the precision of a perfectly drawn line. Part dreamer, part realist, you synchronize your lifestyle with the demands of your heart and mind. You'll find an expression of this rare combination in the bella range of cover panels. Choose from the natural opulence of Bellewood panels, the elegant simplicity of White Jazz, the passion and energy of Metalik, the exuberance of Antik, or the soft-to-touch feel of Bellesoft. The options on offer are simply a myriad.

Bella Spirit Gold Plate with Nixon Titanium Grey Switches



### BELLA COVER PLATES WITH MOUNTING FRAMES

PLATES →	1M	2M	3M*	3M	4M*	6M*	8M(H)*	8M	8M*(V)	8M(V)**	12M*	16M*	18M*
COLOURS ↓	MRP ₹	MRP ₹	MRP ₹	MRP ₹	MRP ₹	MRP ₹	MRP ₹	MRP ₹	MRP ₹	MRP ₹	MRP ₹	MRP ₹	MRP ₹
White Jazz	103.00	103.00	127.00	127.00	148.00	200.00	252.00	293.00	252.00	252.00	315.00	346.00	409.00
Metalik	132.00	132.00	171.00	171.00	192.00	252.00	329.00	367.00	329.00	329.00	414.00	419.00	456.00
Belle Soft	143.00	143.00	186.00	186.00	219.00	282.00	361.00	400.00	361.00	361.00	456.00	467.00	500.00
Antik	173.00	173.00	215.00	215.00	251.00	334.00	450.00	490.00	450.00	450.00	503.00	577.00	637.00
Belle Wood	173.00	173.00	215.00	215.00	251.00	334.00	450.00	490.00	450.00	450.00	503.00	577.00	637.00
CODE →	30101	30201	30301	33301	30401	30601	30801	32801	38801	39801	31201	31601	31801
Outer/Master →	10/400	10/400	10/300	10/300	10/300	5/150	5/150	5/150	5/150	5/150	5/120	5/90	5/80
SIZE(mm) →	93x86	93x86	119x86	125x86	151x86	219x86	268x86	246x86	154x155	152x168	220x155	268x155	225x224

COVER PLATES

\* With Partition \*\*8 Module Vertical Big Size

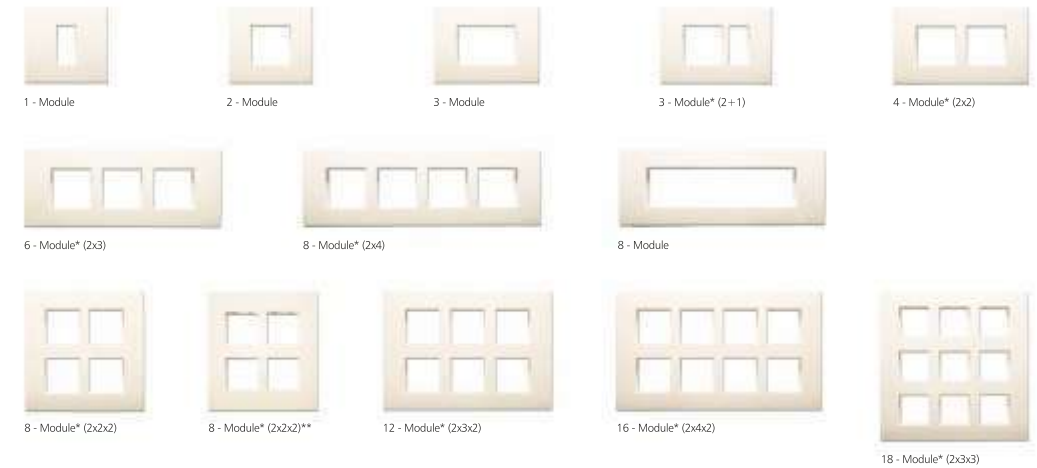

### MOUNTING FRAMES - Horizontal & Vertical Distance for Screwing ( Dimensions in mm )

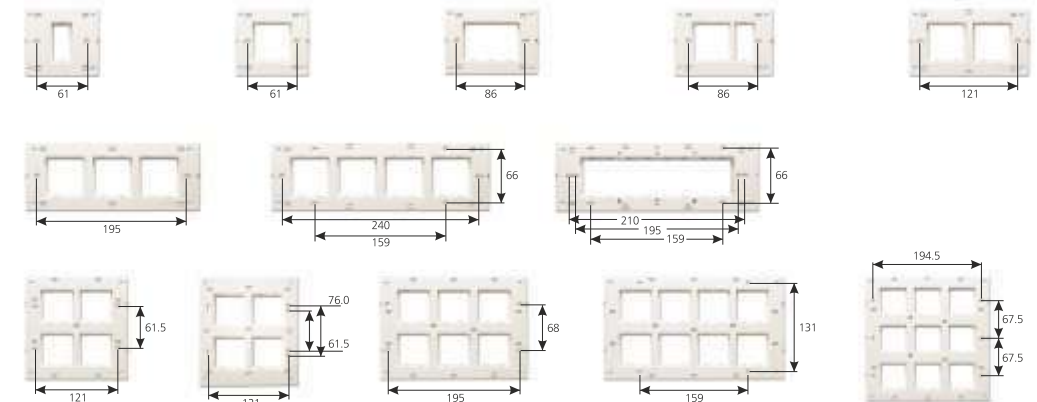

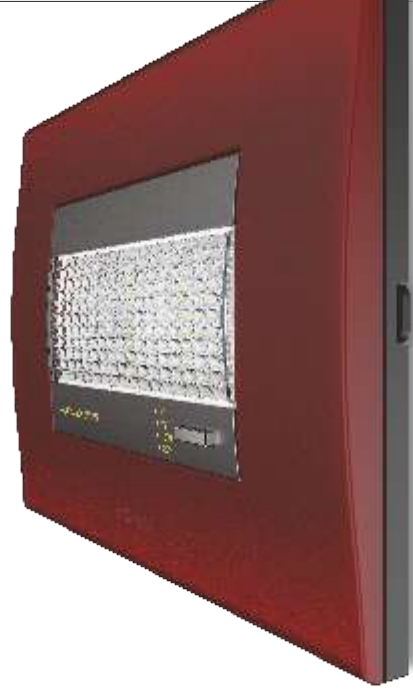

Crisallo Valentine Wfme Plate with Curve Digital Chrome Emergency Light

## Cristallo

With Curve Crisallo, you can create style statements that echo your true self. Choose the clear, transparent Memorio panels to showcase your memories from the past. Select the specially crafted Twixos panels with two-tone colours to lend a distinct verve to your interiors. Or opt for the Illumino panels that emit a soft, gentle glow that inspires as well as guides you in total darkness... Whichever your choice, the Crisallo range doesn't just allow you to express yourself more clearly, it sets trends for the rest to follow.

Crisallo Herbal Spa Plate with Curve Digital Chrome Switches



### CRISTALLO COVER PLATES WITH MOUNTING FRAMES

PLATES	→	1M	2M	3M	3M*	4M*	6M*	8M (H)	8M*	8M* (V)	12M*	16M*	18M*
COLOURS	↓	MRP ₹	MRP ₹	MRP ₹	MRP ₹	MRP ₹	MRP ₹	MRP ₹	MRP ₹	MRP ₹	MRP ₹	MRP ₹	MRP ₹
White Jazz		92.00	92.00	116.00	116.00	131.00	177.00	227.00	258.00	227.00	287.00	317.00	364.00
Memorio		212.00	212.00	257.00	257.00	309.00	395.00	538.00	538.00	538.00	592.00	711.00	810.00
Twixos/Metalik		192.00	192.00	248.00	248.00	286.00	351.00	424.00	424.00	424.00	517.00	577.00	661.00
Wood		214.00	214.00	279.00	279.00	326.00	383.00	473.00	473.00	473.00	577.00	640.00	718.00
CODE	→	40101	40201	40301	43301	40401	40601	40801	42801	48801	41201	41601	41801
Outer/Master	→	10/300	10/300	10/200	10/200	10/200	5/120	5/120	5/120	5/100	5/80	5/40	5/40
SIZE(mm)	→	92x86	92x86	115x86	122x86	150x86	222x86	264x86	248x86	150x151	222x151	264x151	223x217

### COVER PLATES

\* With Partition

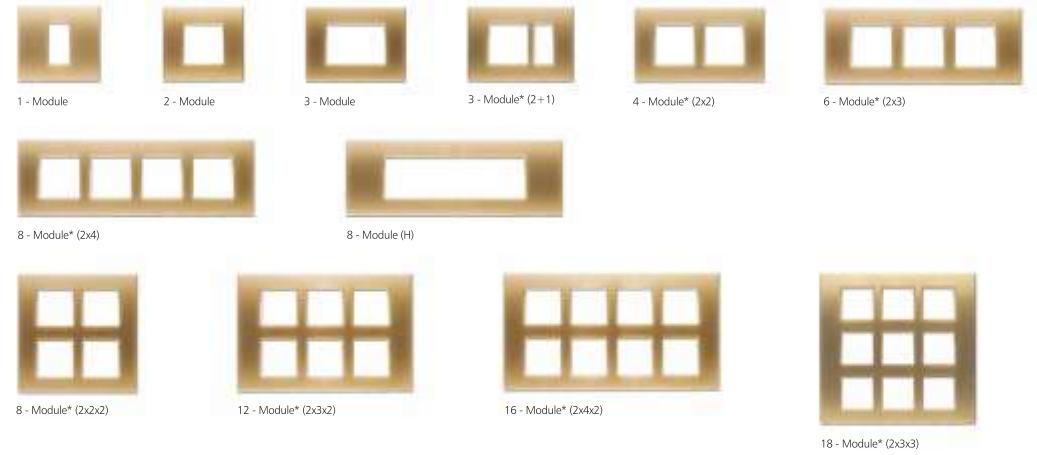

### CRISTALLO MOUNTING FRAMES - Horizontal & Vertical Distance for Screwing [ Dimensions in mm ]

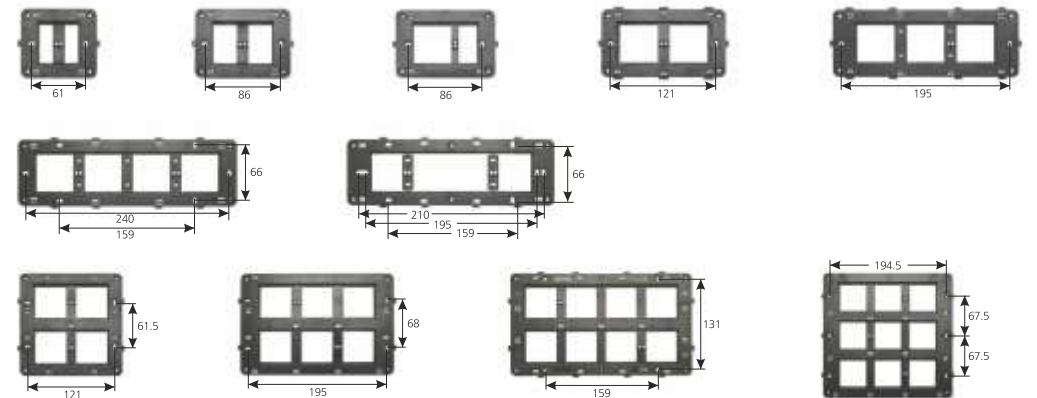



Crystallight - Honey Mint Plate with Nixon Titanium Grey Gas Detector

## QUORRA

The Crystallight cover frames are precisely crafted for that perfect finish – right from their delicately frosted facade to the exquisite chamfer around the edges. Like naturally occurring crystals, the Crystallight cover plate exhibits a rare brilliance that creates an aura of sophisticated elegance around it. Unmatched in their beauty and finish, these cover plates are without doubt, the definitive symbol of luxury on your walls.

Crystallight Grey Ghost Plate with Nixon Titanium Grey Switches



## Crystalight

### QUORRA BASIC COVER PLATES

PLATES	1M	2M	3M	4M	4M*	6M	6M*	8M (H)*	8M	8M*	8M (V)	12M	18M
					(H&V)**		(H&V)**			(H&V)**			
COLOURS	MRP ₹	MRP ₹	MRP ₹	MRP ₹	MRP ₹	MRP ₹	MRP ₹	MRP ₹	MRP ₹	MRP ₹	MRP ₹	MRP ₹	MRP ₹
Satin White	-	135.00	169.00	208.00	-	269.00	-	323.00	323.00	-	323.00	414.00	579.00
Metallic	-	223.00	243.00	286.00	-	344.00	-	415.00	415.00	-	415.00	581.00	712.00
Wood	-	261.00	286.00	357.00	-	415.00	-	515.00	515.00	-	515.00	712.00	943.00
Outer/Master	-	10/400	10/300	10/300	-	5/150	-	5/150	5/150	-	5/150	5/120	5/80

### QUORRA PREMIUM COVER PLATES

Glass	632.00	632.00	841.00	1110.00	1219.00	1508.00	1644.00	-	1700.00	1850.00	1700.00	2039.00	2474.00
CODE	50101	50201	53301	50401	50403	50601	50603	50801	52801	50803	58801	51201	51801
Outer/Master	10/200	10/200	10/200	10/150	10/150	5/100	5/100	-	5/100	5/100	5/100	5/75	5/40
SIZE(mm)	106x91	106x91	128x91	152x91	152x91	226x91	226x91	-	251x91	269x91	152x157	226x157	226x224

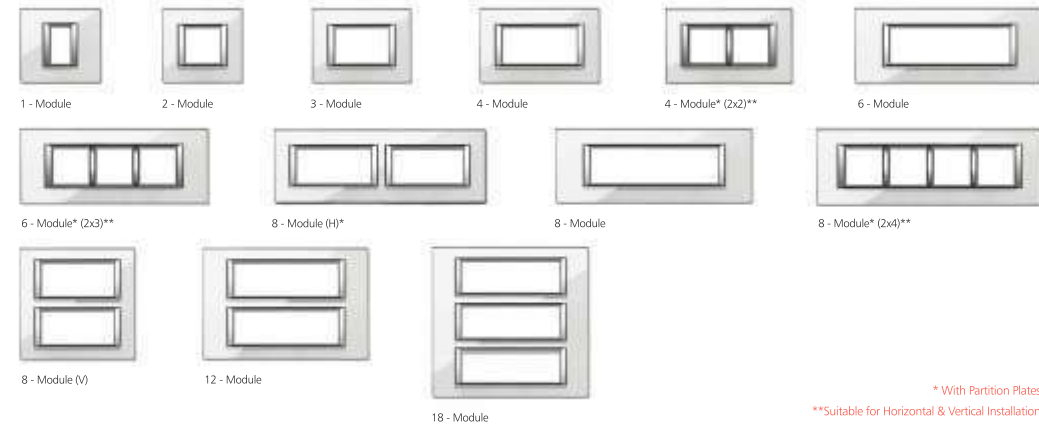

\* With Partition Plates

\*\* Suitable for Horizontal & Vertical Installation

### QUORRA MOUNTING FRAME - Horizontal & Vertical Distance for Screwing [ Dimensions in mm ]

Quorra Frame	2M	3M	4M	4M	6M	6M	8M (H)*	8M	8M	8M (V)	12M	18M
					(H&V)**		(H&V)**			(H&V)**		
MRP ₹	66.00	81.00	93.00	99.00	136.00	148.00	170.00	170.00	185.00	170.00	221.00	299.00
CODE	50202	53302	50402	50404	50602	50604	50802	52802	50804	58802	51202	51802
Outer/Master	25/750	25/750	25/500	25/500	20/240	20/240	20/240	20/240	20/240	20/240	20/160	10/80

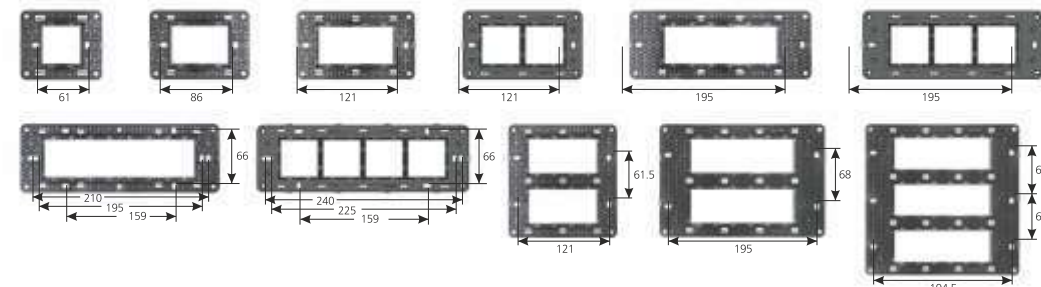



Xtreme Brushed Silver Plate with Nixon Titanium Grey Step Marker

## QUORRA

Fashioned from wood, glass, metal, chrome, stone and wool, the Quorra Xtreme cover frames are distinguished by their sleek chrome encasing. Visible from the sides as well as the front, the chrome border creates an aura of luxury and sophistication around the frames. While the Quorra Xtreme is superlative in every respect, the Quorra Xtreme is the epitome of flawless grandeur: diamond cut and polished to perfection. Painstakingly crafted, Quorra cover frames symbolizes the absolute pinnacle of luxurious living.

## XTREME

Xtreme Brushed Silver Plate with 3M Bluetooth FM Player



### QUORRA CRYSTALLIGHT / DIAMOND COVER PLATES

PLATES	1M	2M	3M	4M	4M*	6M	6M*	8M	8M*	8M (V)	12M	18M
					(H&V)**		(H&V)**		(H&V)**			
COLOURS	MRP ₹	MRP ₹	MRP ₹	MRP ₹	MRP ₹	MRP ₹	MRP ₹	MRP ₹	MRP ₹	MRP ₹	MRP ₹	MRP ₹
Glass (diamond cut)	714.00	714.00	947.00	1246.00	1371.00	1796.00	1890.00	2019.00	2082.00	2019.00	2298.00	2815.00
Diamond (studded)	-	-	5255.00	-	-	-	-	-	-	-	-	-

### QUORRA XTREME COVER PLATES

Aluminum	653.00	653.00	918.00	1219.00	1342.00	1726.00	1870.00	1990.00	2063.00	1990.00	2290.00	2819.00
CODE	50101	50201	53301	50401	50403	50601	50603	52801	50803	58801	51201	51801
Outer/Master	10/200	10/200	10/200	10/150	10/150	5/100	5/100	5/100	5/100	5/100	5/75	5/40
SIZE(mm)	106x91	106x91	128x91	152x91	152x91	226x91	226x91	251x91	269x91	152x157	226x157	226x224

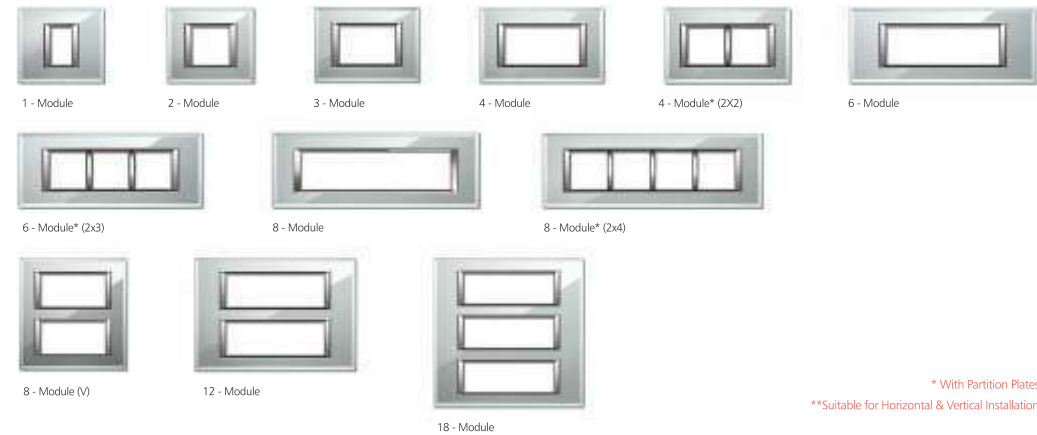

\* With Partition Plates  
\*\* Suitable for Horizontal & Vertical Installation

### QUORRA XTREME COVER PLATES

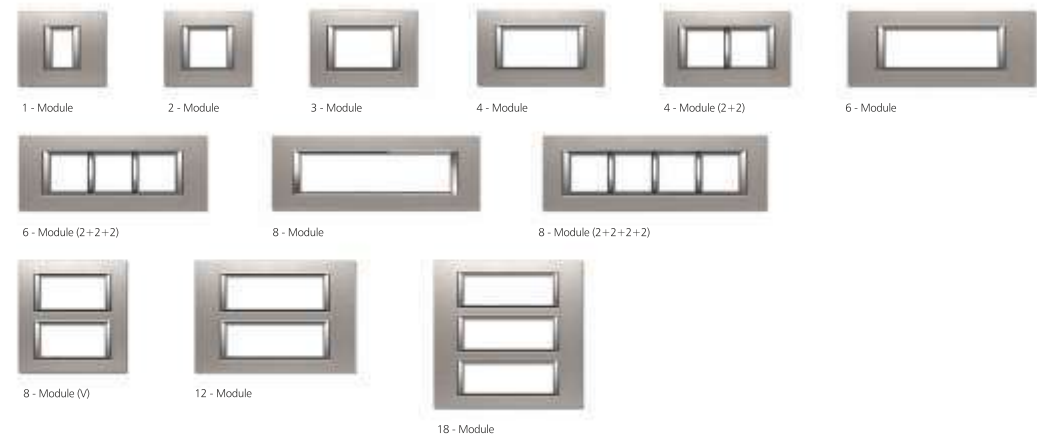



Grazia Basic Absolute White Plate with Nixon Absolute White Switches

## grazia

Grazia, the thinnest, most stylish cover frames you can imagine, are available in Basic and Premium options. Both Basic and Premium cover frames accentuate the style quotient of your rooms with their distinctively slender appearance. The Grazia Premium has an additional chrome side casing which highlights the delightful slimmness of these cover frames. Choose from either of these options to make a style statement that will always be in.

Grazia Premium Absolute White Plate with Nixon Digital Silver Key Tag



### GRAZIA BASIC COVER PLATES WITH MOUNTING FRAMES

PLATES →	1M	2M	3M	3M*	4M	4M*	6M	6M*	8M	8M*	8M	9M*	12M	12M*	12M*	16M	18M
						(H&V)**		(H&V)**		(H&V)**	(V)				(H&V)**		
COLOURS ↓	MRP ₹	MRP ₹	MRP ₹	MRP ₹	MRP ₹	MRP ₹	MRP ₹	MRP ₹	MRP ₹	MRP ₹	MRP ₹	MRP ₹	MRP ₹	MRP ₹	MRP ₹	MRP ₹	MRP ₹
Pure Glossy	111.00	111.00	137.00	137.00	170.00	170.00	240.00	240.00	301.00	301.00	301.00	323.00	350.00	350.00	350.00	393.00	457.00
Metallic	160.00	160.00	207.00	207.00	252.00	252.00	347.00	347.00	434.00	434.00	434.00	465.00	515.00	515.00	515.00	571.00	588.00
Wood	216.00	216.00	294.00	294.00	359.00	359.00	489.00	489.00	669.00	669.00	669.00	673.00	696.00	696.00	696.00	778.00	841.00

### GRAZIA PREMIUM COVER PLATES WITH MOUNTING FRAMES

Pure Glossy	130.00	130.00	160.00	160.00	195.00	195.00	279.00	279.00	354.00	354.00	354.00	379.00	410.00	410.00	410.00	467.00	541.00
CODE →	60101	60201	60301	60303	60401	60404	60601	60604	60801	60804	68801	60901	61201	61204	61207	61601	61801
Outer/Master	10/400	10/400	10/300	10/300	10/300	10/300	5/150	5/150	5/150	5/150	5/150	5/150	5/120	5/120	5/120	5/90	5/80
SIZE(mm) →	101x93	101x93	124x93	124x93	148x93	154x93	221x93	226x93	247x93	280x93	148x159	280x93	222x160	226x160	226x160	246x159	222x226

\* With Partition Plates

\*\* Suitable for Horizontal & Vertical Installation

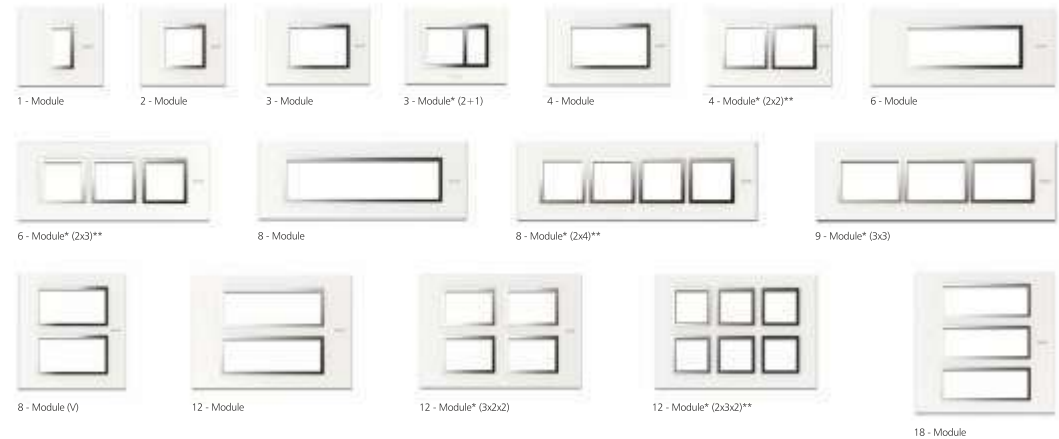

### GRAZIA MOUNTING FRAMES - Horizontal & Vertical Distance for Screwing [ Dimensions in mm ]

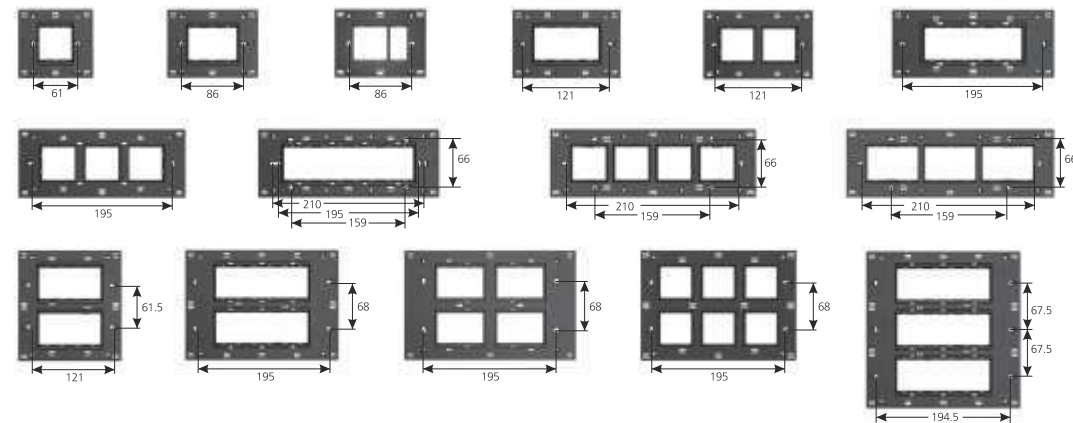



Classio Black Walnut Plate with Digital Silver I-Touch WiFi Switch

**GLASSIO**

The Glassio is without doubt a classical beauty – exhibiting a smooth, glossy frontage, with soft, rounded edges and a demeanour that’s sophisticated yet warm and welcoming. The elegantly flared corners reflect and absorb light in a manner that adds depth and character to the cover plate. This interplay of light and shadow also creates a sinuous effect that makes Glassio the definitive artefact on your wall.

Classio Moughal Teak Plate with Digital Silver I-Touch WiFi Regulator



**GLASSIO COVER PLATES WITH MOUNTING FRAMES**

PLATES →	1M	2M	3M	4M	4M*	6M	6M*	8M	8M*	8M	12M	12M*	16M*	18M
					(H&V)**		(H&V)**		(H&V)**	(V)		(H&V)**		
COLOURS ↓	MRP ₹	MRP ₹	MRP ₹	MRP ₹	MRP ₹	MRP ₹	MRP ₹	MRP ₹	MRP ₹	MRP ₹	MRP ₹	MRP ₹	MRP ₹	MRP ₹
Pure Glossy	130.00	130.00	160.00	195.00	195.00	279.00	279.00	354.00	354.00	354.00	405.00	405.00	455.00	534.00
Metallic	175.00	175.00	229.00	279.00	279.00	381.00	381.00	478.00	478.00	478.00	560.00	560.00	629.00	694.00
Metal Krome	262.00	262.00	365.00	443.00	443.00	595.00	595.00	799.00	799.00	799.00	822.00	822.00	900.00	982.00
Wood	237.00	237.00	318.00	389.00	389.00	538.00	538.00	727.00	727.00	727.00	779.00	779.00	863.00	910.00
CODE →	120101	120201	120301	120401	120404	120601	120604	120801	120804	128801	121201	121204	121601	121801
Outer/Master →	10/500	10/500	10/400	10/400	10/400	5/200	5/200	5/200	5/200	5/200	5/120	5/120	5/90	5/80
SIZE(mm) →	92x90	92x90	120x90	146x90	152x90	219x90	219x90	244x90	264x90	152x168	219x156	219x156	244x156	219x223

\* With Partition Plates

\*\*Suitable for Horizontal & Vertical Installation

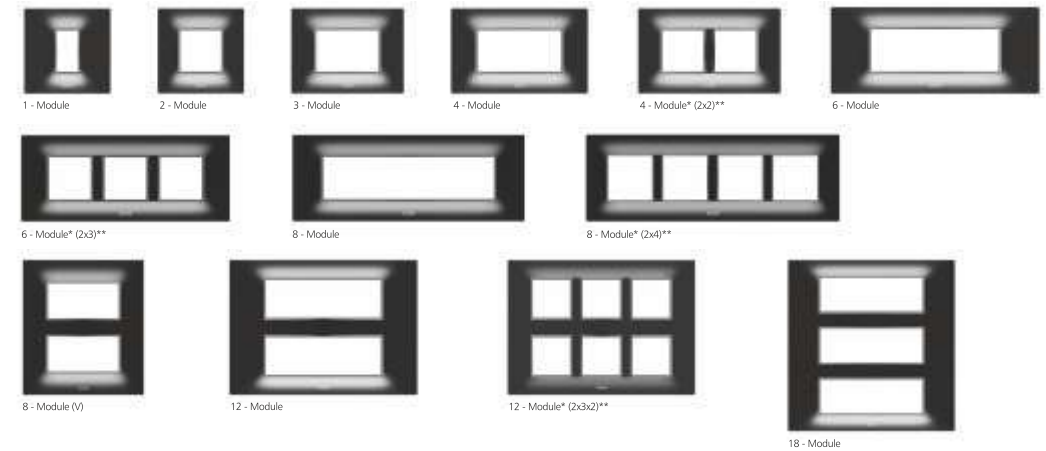

**GLASSIO MOUNTING FRAMES - Horizontal & Vertical Distance for Screwing | Dimensions in mm |**

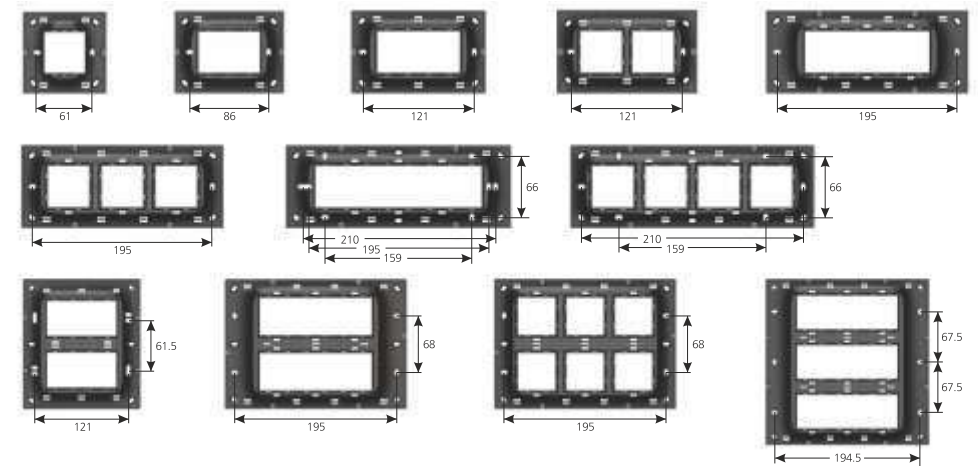



Wega Green Switch Plate with Titanium Grey G-dip Switches

# WEGA

Unconventional yet perfectly symmetrical, bold yet elegant - the Wega cover plates are stunning in every way. An example of imagination and engineering precision of the highest order, the Wega, with its distinctive appearance stands out from the clutter with ease. Its undulating shape creates a magical interplay of light that adds to its visual appeal. The colours appear dazzling, mesmerizing and even playful, depending on the prevailing light conditions.

Wega Red Fever Plate with Digital Silver Step Marker



NEW

### WEGA COVER PLATES WITH MOUNTING FRAMES

PLATES →	1M	2M	3M	4M	4M*	6M	6M*	8M	8M*	8M	12M	16M	18M
					(H&V)**		(H&V)**		(H&V)**	(V)			
COLOURS ↓	MRP ₹	MRP ₹	MRP ₹	MRP ₹	MRP ₹	MRP ₹	MRP ₹	MRP ₹	MRP ₹	MRP ₹	MRP ₹	MRP ₹	MRP ₹
Pure Glossy	-	217.00	286.00	346.00	346.00	440.00	418.00	544.00	523.00	544.00	664.00	750.00	949.00
Metallic	-	332.00	386.00	470.00	470.00	547.00	525.00	672.00	652.00	672.00	958.00	1045.00	1164.00
Wood	-	380.00	442.00	525.00	525.00	631.00	610.00	799.00	777.00	799.00	1105.00	1337.00	1387.00
CODE →	200101	200201	200301	200401	200403	200601	200603	200801	200803	208801	201201	201601	201801
Outer/Master →	10/400	10/400	10/300	10/300	10/300	5/150	5/150	5/150	5/150	5/150	5/120	5/90	5/80
SIZE(mm) →	94x92	94x92	122x92	148x92	154x92	221x92	221x92	246x92	266x92	154x170	221x159	221x159	221x225

\* With Partition Plates

\*\* Suitable for Horizontal & Vertical Installation

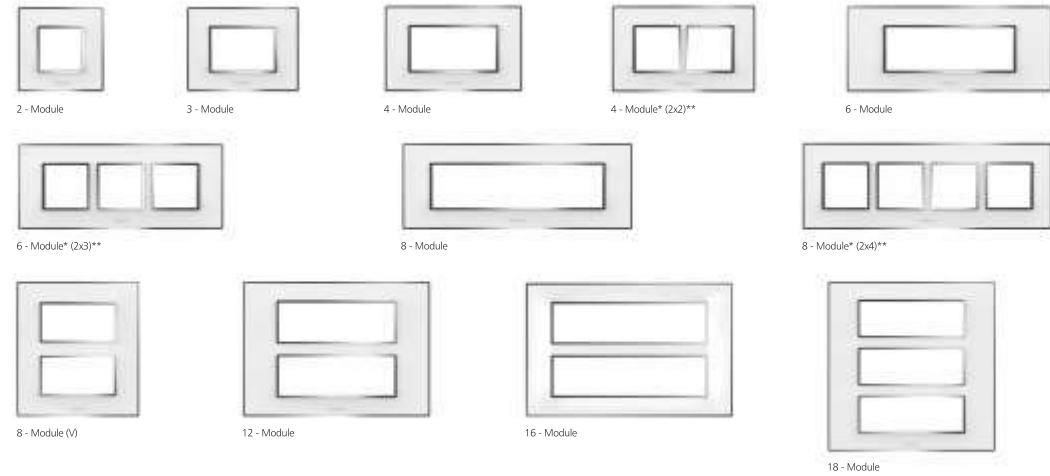

### WEGA MOUNTING FRAMES - Horizontal & Vertical Distance for Screwing ( Dimensions in mm )

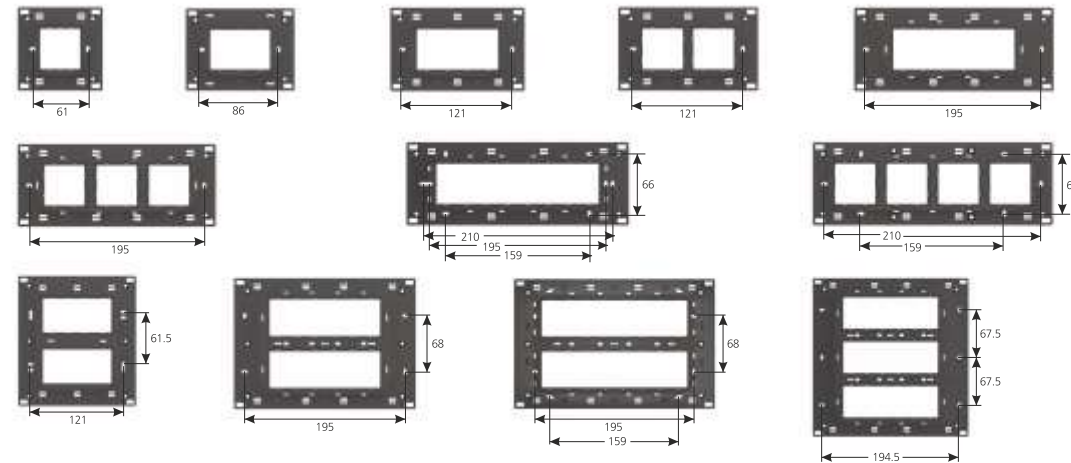

COLOURS OF COVER PLATES

PURE GLOSSY



01 - Absolute White

METALLIC



05 - Champagne Gold



06 - Titanium Silver



07 - Titanium Grey



08 - Atomic Blue



09 - Green Witch



10 - Nuclear Grey



11 - Purple Passion



12 - Red Fever



13 - Gaga Blue



14 - Lusty Ginger



15 - Puppy Brown

WOOD



21 - Jungle Wenge



22 - Dark Espresso



23 - Tom & Jerry



24 - Tortilla Wood

Colours shown may not match actual product colours due to printing limitations.

COLOURS OF COVER PLATES

WHITE JAZZ



01 - White Jazz

METALIK



06 - Spirit Gold



07 - Silver Streak



08 - Copper

*bella*

BELLESOFT



09 - Digital Chrome

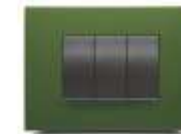

16 - Pepper Leaf



17 - Deep Currant



18 - Blu Caspian

ANTIK



19 - Voltage Grey



31 - Antik Copper



41 - African Wenge



42 - Burma Teak

BELLEWOOD

WHITE JAZZ



01 - White Jazz

*Cristallo*

TWIXOS



06 - Valentine Wine



07 - Herbal Spa



08 - Plum Island



09 - Ice Grey

Metalik



21 - Ocean Pearl



22 - Gold

Wood



31 - Fumed Oak

Colours shown may not match actual product colours due to printing limitations.

COLOURS OF COVER PLATES

PURE GLOSSY



01 - Absolute White



02 - Black Glossy



03 - Ivory Gold

METALLIC



06 - Digital Chrome\*

METAL KROME



10 - Hyper Chrome

WOOD



15 - Black Walnut



16 - Moughal Teak

grazia

PURE GLOSSY



01 - Absolute White

METALLIC



05 - Digital Silver

WOOD



10 - Italian Espresso



11 - Zebra Wood

PURE GLOSSY



15 - Absolute White

premium

COLOURS OF COVER PLATES

BASIC



01 - Satin White

METALLIC



06 - Digital Silver

BASIC WOOD



10 - Fumed Oak

basic

GLASS



16 - Snow White



17 - Red Wine



18 - Green Ice



19 - Rich Black

premium



20 - Hot Red

GLASS



25 - Mint Ice



26 - Honey Sapphire



27 - Magic Mirror



28 - Honey Mint

Crystal<sup>light</sup>



29 - Grey Ghost

XTREME



35 - Brushed Black



36 - Brushed Silver

Colours shown may not match actual product colours due to printing limitations.

# Air

Flat. Flawless.  
Flamboyant.

# Aura

The Aura has a forceful presence that commands attention. With its perfect, crisp lines and distinct shape, the Aura highlights the precision and style that defines the Air range. The Aura is the perfect choice for interiors that are practical yet modern.

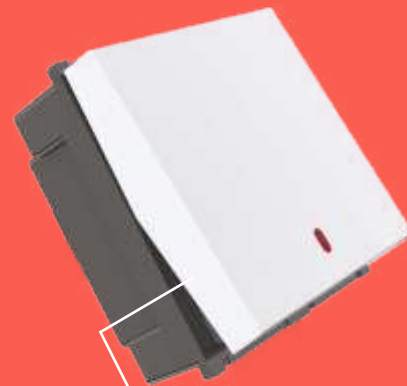

Perfect crisp lines that define the Air range

# Aero

The Aero redefines flat switches. Styled to remain absolutely flush with the cover plate, the Aero emphasizes the minimalistic design of the Air range. Manufactured using the very best in raw materials and processes, the Aero is both functionally and aesthetically a class apart!



Completely flat - at OFF position

# Arc

The Arc switches by Air symbolizes minimalistic elegance. Easy on the eye as well as a pleasure to use, the Arc can be the perfect accessory in stylish homes with graceful settings. Crafted to perfection using the very best in technology and materials, the Arc adds a new dimension to your interiors.

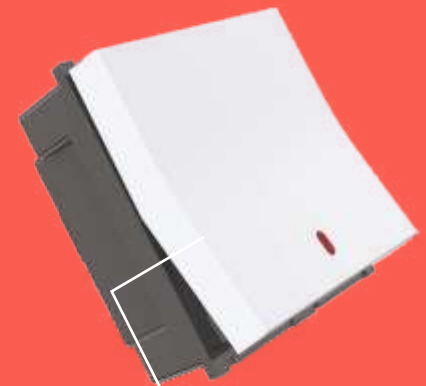

A symbol of elegant minimalism

# Distinctly flat, slim and minimal

The AIR range of modular switches and systems breaks the mold with its classy, minimalistic, uniquely flat, and slim appearance. An example of meticulous craftsmanship, careful detailing, and unmatched excellence, the AIR range makes other ordinary switch ranges appear unwieldy and extravagant. Absolutely light and modern, the AIR range marks a new beginning in the world of standard fittings. Slim, stylish, minimal – the AIR devices shout quality, elegance, and finesse through every inch of their presence.



A7 Plate -  
Artio Bell Push Switch with Indicator



A7 Plate -  
Motor Stater Switch with Indicator



A7 Plate -  
Aero Switches with Indicator



A7 Plate -  
65W C Type Charger



A7 Plate -  
Step Marker

A7 Plate -  
i-Push Step Marker



A7 Plate -  
8 Step Regulator



A7 Plate -  
Wi-Fi Switches

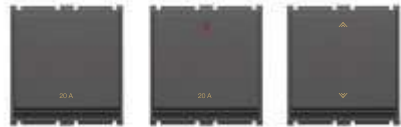
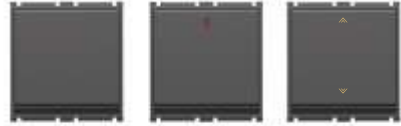

Code	Item	MRP ₹		Pkg.
		Absolute White	Carbon Grey	
<b>AERO 10AX SWITCHES 240V~ ( 1 Module )</b>				
181001	1 Way Switch	75.00	81.00	20/600
181002	1 Way Switch with Ind. (LED)	129.00	142.00	20/600
181003	2 Way Switch	142.00	156.00	20/600
181004	Bell Push Switch	150.00	164.00	20/600
181005	Bell Push Switch with Ind. (LED)	168.00	185.00	20/600

Code	Item	MRP ₹		Pkg.
		Absolute White	Carbon Grey	
<b>AERO 10AX SWITCHES 240V~ ( 2 Module )</b>				
182010	1 Way Switch	120.00	132.00	10/300
182011	1 Way Switch with Ind. (LED)	138.00	150.00	10/300
182012	2 Way Switch	193.00	212.00	10/300
182014	Bell Push Switch with Ind. (LED)	216.00	238.00	10/300

Code	Item	MRP ₹		Pkg.
		Absolute White	Carbon Grey	
<b>AERO 20 / 25AMP SWITCHES 240V~ ( 1 Module )</b>				
181020	20A 1 Way Switch	175.00	192.00	20/600
181021	20A 1 Way Switch with Ind. (LED)	213.00	231.00	20/600
181022	20A 2 Way Switch	224.00	244.00	20/600
181023	25A 1 Way Switch	228.00	251.00	20/600

Code	Item	MRP ₹		Pkg.
		Absolute White	Carbon Grey	
<b>AERO 20AMP SWITCHES 240V~ ( 2 Module )</b>				
182025	1 Way Switch	219.00	241.00	10/300
182026	1 Way Switch with Ind. (LED)	246.00	270.00	10/300
182027	2 Way Switch	274.00	300.00	10/300

Code	Item	MRP ₹		Pkg.
		Absolute White	Carbon Grey	
<b>AERO 32AMP DP SWITCH 240V~ ( 2 Module )</b>				
182031	32A DP Switch with Indicator (LED)	413.00	454.00	10/300

Code	Item	MRP ₹		Pkg.
		Absolute White	Carbon Grey	
<b>ARC 10AX SWITCHES 240V~ ( 1 Module )</b>				
181401	1 Way Switch	70.00	76.00	20/600
181402	1 Way Switch with Ind. (LED)	121.00	132.00	20/600
181403	2 Way Switch	133.00	147.00	20/600
181404	Bell Push Switch	139.00	151.00	20/600
181405	Bell Push Switch with Ind. (LED)	155.00	171.00	20/600

Code	Item	MRP ₹		Pkg.
		Absolute White	Carbon Grey	
<b>ARC 10AX SWITCHES 240V~ ( 2 Module )</b>				
182410	1 Way Switch	106.00	116.00	10/300
182411	1 Way Switch with Ind. (LED)	123.00	136.00	10/300
182412	2 Way Switch	174.00	191.00	10/300
182414	Bell Push Switch with Ind. (LED)	197.00	216.00	10/300

Code	Item	MRP ₹		Pkg.
		Absolute White	Carbon Grey	
<b>ARC 20 / 25AMP SWITCHES 240V~ ( 1 Module )</b>				
181420	20A 1 Way Switch	159.00	175.00	20/600
181421	20A 1 Way Switch with Ind. (LED)	199.00	219.00	20/600
181422	20A 2 Way Switch	210.00	231.00	20/600
181423	25A 1 Way Switch	218.00	240.00	20/600

Code	Item	MRP ₹		Pkg.
		Absolute White	Carbon Grey	
<b>ARC 20AMP SWITCHES 240V~ ( 2 Module )</b>				
182425	1 Way Switch	193.00	213.00	10/300
182426	1 Way Switch with Ind. (LED)	219.00	241.00	10/300
182427	2 Way Switch	243.00	267.00	10/300

Code	Item	MRP ₹		Pkg.
		Absolute White	Carbon Grey	
<b>ARC 32AMP DP SWITCH 240V~ ( 2 Module )</b>				
182431	32A DP Switch with Indicator (LED)	371.00	407.00	10/300

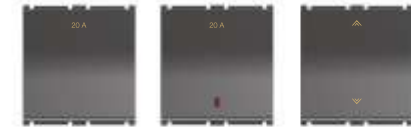
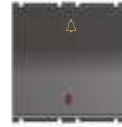



Code	Item	MRP ₹		Pkg.
		Absolute White	Carbon Grey	
<b>AURA 10AX SWITCHES 240V- ( 1 Module )</b>				
181501	1 Way Switch	70.00	76.00	20/600
181502	1 Way Switch with Ind. (LED)	121.00	132.00	20/600
181503	2 Way Switch	133.00	147.00	20/600
181504	Bell Push Switch	139.00	151.00	20/600
181505	Bell Push Switch with Ind. (LED)	155.00	171.00	20/600

Code	Item	MRP ₹		Pkg.
		Absolute White	Carbon Grey	
<b>AURA 10AX SWITCHES 240V- ( 2 Module )</b>				
182510	1 Way Switch	106.00	116.00	10/300
182511	1 Way Switch with Ind. (LED)	123.00	136.00	10/300
182512	2 Way Switch	174.00	191.00	10/300
182514	Bell Push Switch with Ind. (LED)	197.00	216.00	10/300

Code	Item	MRP ₹		Pkg.
		Absolute White	Carbon Grey	
<b>AURA 20 / 25AMP SWITCHES 240V- ( 1 Module )</b>				
181520	20A 1 Way Switch	159.00	175.00	20/600
181521	20A 1 Way Switch with Ind. (LED)	199.00	219.00	20/600
181522	20A 2 Way Switch	210.00	231.00	20/600
181523	25A 1 Way Switch	218.00	240.00	20/600

Code	Item	MRP ₹		Pkg.
		Absolute White	Carbon Grey	
<b>AURA 20AMP SWITCHES 240V- ( 2 Module )</b>				
182525	1 Way Switch	193.00	213.00	10/300
182526	1 Way Switch with Ind. (LED)	219.00	241.00	10/300
182527	2 Way Switch	243.00	267.00	10/300

Code	Item	MRP ₹		Pkg.
		Absolute White	Carbon Grey	
<b>AURA 32AMP DP SWITCH 240V- ( 2 Module )</b>				
182531	32A DP Switch with Indicator (LED)	371.00	407.00	10/300

Code	Item	MRP ₹		Pkg.
		Absolute White	Carbon Grey	
<b>ARTIO BELL PUSH SWITCH 240V- ( 2 Module )</b>				
182313	Bell Push Switch	141.00	155.00	10/300

Code	Item	MRP ₹		Pkg.
		Absolute White	Carbon Grey	
<b>32A NANO DP SWITCH 240V- ( 2 Module )</b> <span style="color: red;">NEW</span>				
182076	32A DP Switch with Indicator (LED)	408.00	448.00	10/300

Code	Item	MRP ₹		Pkg.
		Absolute White	Carbon Grey	
<b>6AMP SOCKETS 240V- ( 2 Module )</b>				
182038	6A 3 Pin Socket with safety shutter	116.00	127.00	10/450

Code	Item	MRP ₹		Pkg.
		Absolute White	Carbon Grey	
<b>6&amp;16AMP SOCKETS 240V- ( 2 Module )</b>				
182041	*6&16A Universal Socket with safety shutter	243.00	266.00	10/450
182042A	*6&16A Universal Power Socket with safety shutter	265.00	289.00	10/450
182043	6&16A Universal Raised Socket with safety shutter	243.00	266.00	10/450
182044	6&16A Universal Socket with flap, indicator & safety shutter	243.00	266.00	10/450
* (Suggested to use with a partition plate)				

Code	Item	MRP ₹		Pkg.
		Absolute White	Carbon Grey	
<b>DIMMER / FAN REGULATOR 240V- ( 1 Module )</b>				
181045	Dimmer - 450W	300.00	329.00	20/600
181050	4 Step Regulator- Full Rotary	429.00	470.00	20/600
181051	4 Step Regulator	429.00	470.00	20/600
(Regulator Supplied in ISI & Non ISI)				

Code	Item	MRP ₹		Pkg.
		Absolute White	Carbon Grey	
<b>FULL ROTARY FAN REGULATOR 240V- ( 2 Module )</b>				
182049	8 Step Regulator - Full Rotary <span style="color: red;">NEW</span>	564.00	611.00	10/300
182052	Tri-Star 5 Step Regulator - Full Rotary	509.00	557.00	10/300
182053	Orion 5 Step Regulator - Full Rotary	509.00	557.00	10/300
182054	5 Step Regulator - Full Rotary	509.00	557.00	10/300
(Regulator Supplied in ISI & Non ISI)				

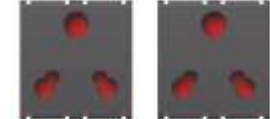
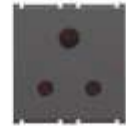

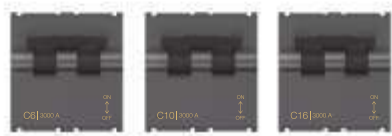

Code	Item	MRP ₹		Pkg.
		Absolute White	Carbon Grey	
<b>MOTOR STARTER (SP) 240V~ 50-60Hz ( 2 Module )</b>				
182059	25A Motor Starter Switch	607.00	668.00	10/300
<b>TV SOCKET / RJ-11 TELEPHONE JACKS / EDP SOCKET ( 1 Module )</b>				
181062	TV Socket Coaxial 40-862 Mhz Socket	127.00	140.00	20/900
181068	Telephone Jack - RJ 11	134.00	148.00	20/600
181074	EDP Socket Outlet - RJ 45 (Cat 6e) Category 6e, Universal wiring T568A, insulating-piercing terminal	623.00	685.00	20/600
<b>SINGLE POLE MCBs 240/450V~ ( 1 Module )</b>				
181077	C6 SP MCB	360.00	396.00	20/600
181078	C10 SP MCB	360.00	396.00	20/600
181079	C16 SP MCB	360.00	396.00	20/600
181080	C20 SP MCB	360.00	396.00	20/600
181081	C25 SP MCB	360.00	396.00	20/600
181082	C32 SP MCB	360.00	396.00	20/600
	240/450V~ 50-60Hz 3kA Breaking Capacity			
<b>DOUBLE POLE MCBs 240/450V~ ( 2 Module )</b>				
182083	C6 DP MCB	743.00	817.00	10/300
182084	C10 DP MCB	743.00	817.00	10/300
182085	C16 DP MCB	743.00	817.00	10/300
182086	C20 DP MCB	743.00	817.00	10/300
182087	C25 DP MCB	743.00	817.00	10/300
182088	C32 DP MCB	743.00	817.00	10/300
	240/450V~ 50-60Hz 3kA Breaking Capacity			
<b>INDICATOR / FUSE UNIT / BLANK MODULE ( 1 Module )</b>				
181093	Indicator with LED & Red Diffuser	111.00	121.00	20/600
181094	Indicator with LED & Red Diffuser	111.00	121.00	20/600
181098	Fuse Carrier [10Amp/16Amp] with miniature fuse dia 6.3x28	152.00	167.00	20/600
181125	Blank Module	33.00	36.00	50/2000

Code	Item	MRP ₹		Pkg.
		Absolute White	Carbon Grey	
<b>STEP MARKER 240V~</b>				
182105	Step Marker [2M]	605.00	660.00	10/300
182105WW	Step Marker [Warm White LED] [2M] Supply voltage 240V- 50-60Hz with high-efficiency 5x0.2W LED	605.00	660.00	10/300
183106	Step Marker [Warm White LED] [3M] Supply voltage 240V- 50-60Hz with high-efficiency 6x0.2W LED	718.00	784.00	5/100
<b>ELECTRONIC BELL / 32A MAIN SWITCH 240V~ ( 2 Module )</b>				
182139	Electronic Bell 240V-50-60Hz	369.00	408.00	10/300
182163	32A DP Operated by Key Tag 240V~, LED Supplied with Key Tag	493.00	541.00	10/300
182164	Only Key Tag with Name Plate	106.00	116.00	100/2000
<b>DND/MAKE MY ROOM ( 2 Module )</b>				
182168#	Do Not Disturb/Make My Room 240V- 50-60Hz - Inside Room	453.00	498.00	10/300
182169#	Do Not Disturb/Make My Room 240V- 50-60Hz - Outside Room	485.00	534.00	10/300
<b>USB CHARGER 240V~</b>				
182170	65W C-Type Fast Charger - Single Port [2M] <b>NEW</b> Supply voltage 160-240V- 50-60Hz Output - PD USB Charger C type [Max 65W]	2200.00	2300.00	10/150
181171	USB Fast Charger - Single Port [1M] Supply voltage 160-240V- 50-60Hz Output - 5V=1.50A / 9V=1.45A, A type [Max 14W]	1034.00	1136.00	10/300
182173	USB Charger with 2 USB Ports [2M] Supply voltage 160-240V- 50-60Hz Output - 5V DC, 2A, A type [Total]	1001.00	1101.00	10/150
181175	18W C-Type Fast Charger - Single Port [1M] Supply voltage 160-240V- 50-60Hz Output - 5V=2.5A / 9V=2A / 12V=1.5A USB Charger C type [Max 18W]	1469.00	1534.00	10/300
181176	30W C-Type Fast Charger - Single Port [1M] <b>NEW</b> Supply voltage 160-240V- 50-60Hz Output - 5V=3A, 9V=3A, 12V=2.5A, 15V=2A, 20V=1.5A USB Charger C type [Max 30W]	1650.00	1750.00	10/300
<b>STEP MARKER 240V~</b>				
184107	Footlight Step Marker [4M] Supply voltage 240V- 50-60Hz with high-efficiency 5x0.2W LED	859.00	941.00	5/120
182108	Push Step Marker [White LED] [2M] Supply voltage 240V- 50-60Hz with high-efficiency 2x0.5W LED	672.00	735.00	10/300

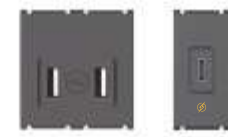

# Products will be supplied from CENTRAL WAREHOUSE



i-Smart - WiFi Panel (Black Glass)  
4 Switch + Fan Regulator + 1 USB Port C type

Designed to simplify daily routines and enhance everyday living, the AIR i-Smart is a premium Wi-Fi glass panel with tactile switches, a fan regulator, and USB Type-C fast charging. Built-in Wi-Fi enables app and voice control via the G-Word App, Amazon Alexa, and Google Home. Responsive buttons deliver smooth five-step fan speed control, while smart scenes, scheduling, and automation add convenience. The sleek glass finish and easy installation in standard junction boxes make it ideal for modern interiors.



i-Smart - WiFi Panel (White Glass)  
4 Switch + Fan Regulator + 1 USB Port C type

Code	Item	MRP ₹		Pkg.
		Absolute White	Carbon Grey	
<b>i-SMART WI-FI 6A SWITCHES</b>				
181185#	i-Smart 6A Switch (1M)	1956.00	2146.00	5/100
182189#	i-Smart 6A 2 Switch (2M) Supply voltage 160-240V~, 6A relay output Operating load (CFL & LED): 100W Max (per switch) Wi-Fi : 2.4GHz	2554.00	2771.00	5/100
<b>i-SMART WI-FI 20A SWITCH ( 2 Module )</b>				
182190#	i-Smart 20A Switch Supply voltage 160-240V~, 20A relay output Operating load (CFL & LED): 200W Max Air conditioner: 1.5 ton Wi-Fi : 2.4GHz	2554.00	2771.00	5/100
<b>i-SMART WI-FI DIMMER/FAN REGULATOR ( 2 Module )</b>				
182192#	i-Smart Dimmer Supply voltage 160-240V~, Triac Technology with soft end & soft start function Operating load (LED) : 80W (Max) Incandescent Light: 40-450W Wi-Fi : 2.4GHz <b>Not suitable for Fan</b>	3533.00	3859.00	5/100
182196#	i-Smart Fan Regulator Supply voltage 160-240V~ Variable Capacitance based 5 step regulator Operating load (Fan) : 100W Wi-Fi : 2.4GHz Can also be operated via i-World App, Google Home & Alexa	3859.00	4240.00	5/100
<b>i-SMART WI-FI PANEL 240V~ ( 4 Module )</b> <span style="float: right;">GLASS <b>NEW</b></span>				
184204#	i-Smart - WiFi 4 Switch + Fan Reg. + 1 USB Port C Type (With Glass Plate) Supply voltage 160-240V~, 6A relay output Operating load (CFL & LED): 100W Max (per switch) Radio Frequency : 433.92 MHz Variable Capacitance based 5 Step Fan Regulator USB Output: 5V ▬ 3A / 9V ▬ 2.2A / 12V ▬ 1.67A (Max 20W) Can also be operated by RF Remote control-103268 & via G-World Mobile App, Google Home & Alexa	-	7800.00	5/-

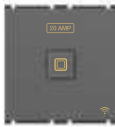
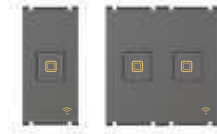



Air A3 Orchid Fusion Plate with Carbon Grey Aero Switch, Orion Regulator

## A3

If you thought practical was dull and boring then you've been looking at the wrong designs. The A3 cover plates will surprise you with their unique combination of practical utility and premium look. Super slim, flat, yet extremely durable, the A3 modular cover plates can easily be the first choice for modern interiors. The distinctive chrome border raises the style quotient of these plates to a higher level! So say yes to practical style that's never boring!

Air A3 Carbon Grey Plate with Carbon Grey Aero Switch, Tri-Star Regulator



A3 COVER PLATES WITH MOUNTING FRAMES															
PLATES →	1M	2M	3M	3M*	4M	4M*	6M	6M*	8M	8M*	8M*	12M*	16M	18M	18M*
						(H&V)**		(H&V)**		(H&V)**	(V)**	(H&V)**			
COLOURS ↓	MRP ₹	MRP ₹	MRP ₹	MRP ₹	MRP ₹	MRP ₹	MRP ₹	MRP ₹	MRP ₹	MRP ₹	MRP ₹	MRP ₹	MRP ₹	MRP ₹	MRP ₹
Pure Glossy	103.00	103.00	138.00	138.00	169.00	169.00	253.00	229.00	349.00	311.00	311.00	371.00	412.00	523.00	457.00
Metallic	128.00	128.00	172.00	172.00	210.00	210.00	317.00	286.00	436.00	390.00	390.00	465.00	516.00	654.00	572.00
CODE →	180101	180201	180301	180303	180401	180403	180601	180603	180801	180803	188803	181203	181601	181801	181803
Outer/Master →	10/500	10/500	10/400	10/400	10/400	10/400	5/200	5/200	5/200	5/200	5/200	5/120	5/90	5/80	5/80
SIZE(mm) →	98x91	98x91	121x91	121x91	152x91	152x91	220x91	220x91	245x91	245x91	152x168	220x157	245x157	220x222	220x222

\* With Partition Plates      \*\* Suitable for Horizontal & Vertical Installation

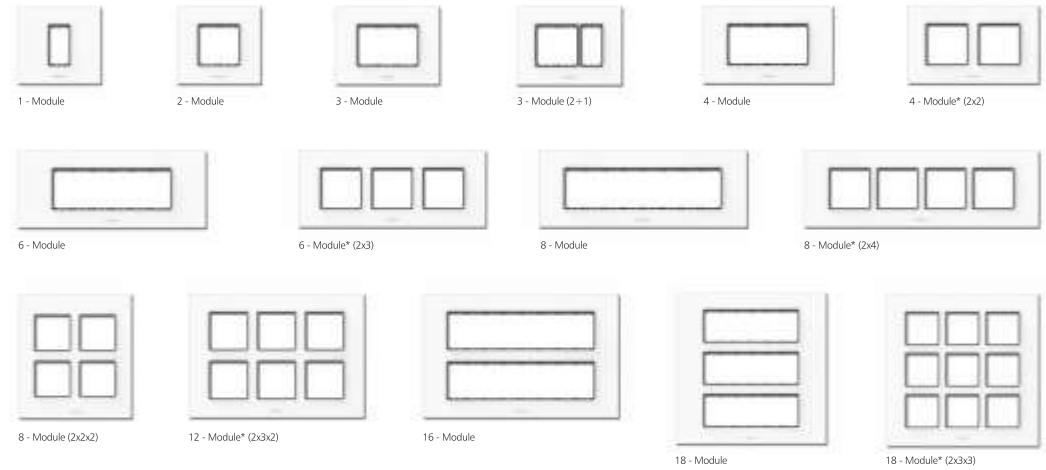

### A3 MOUNTING FRAMES - Horizontal & Vertical Distance for Screwing [ Dimensions in mm ]

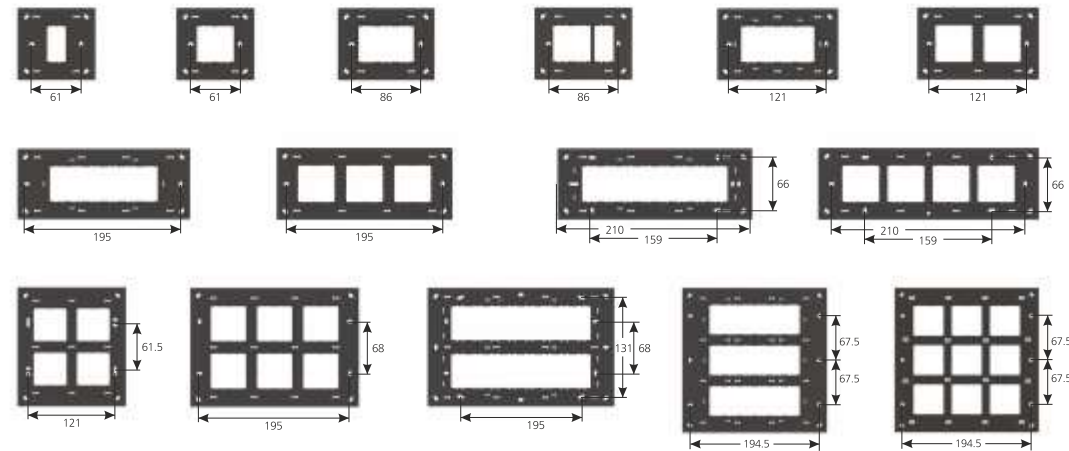



Air A5 Absolute White Plate with Aero Carbon Grey Switches

## A5

The new A5 cover plate is a mix of playful elegance and contemporary styling. Gently curved with rounded corners and a sleek chrome border around the inner frame, the A5 is a refreshingly clean and modern design with a dash of added fun. Like other AIR cover plates, the A5 is restrained in a quiet, refined manner without being dull and boring. Introduce A5 to your interiors to exhibit that rare combination of elegance and charming playfulness!

Air A5 Absolute White Plate With Carbon Grey Arc Switch, Regulator



### A5 BASIC COVER PLATES WITH MOUNTING FRAMES

PLATES →	1M	2M	3M	4M	4M*	6M	6M*	8M	8M*	8M*	12M*	16M	18M	18M*
					(H&V)**		(H&V)**		(H&V)**	(V)**	(H&V)**			(H&V)**
COLOURS ↓	MRP ₹	MRP ₹	MRP ₹	MRP ₹	MRP ₹	MRP ₹	MRP ₹	MRP ₹	MRP ₹	MRP ₹	MRP ₹	MRP ₹	MRP ₹	MRP ₹
Pure Glossy	92.00	92.00	120.00	148.00	148.00	226.00	200.00	304.00	269.00	269.00	344.00	377.00	456.00	397.00
CODE →	220101	220201	220301	220401	220403	220601	220603	220801	220803	228803	221203	221601	221801	221803
Outer/Master →	10/500	10/500	10/400	10/400	10/400	5/200	5/200	5/200	5/200	5/200	5/120	5/90	5/80	5/80
SIZE(mm) →	98x91	98x91	121x91	152x91	152x91	220x91	220x91	245x91	245x91	152x168	220x157	245x157	220x222	220x222

\* With Partition Plates

\*\*Suitable for Horizontal & Vertical Installation

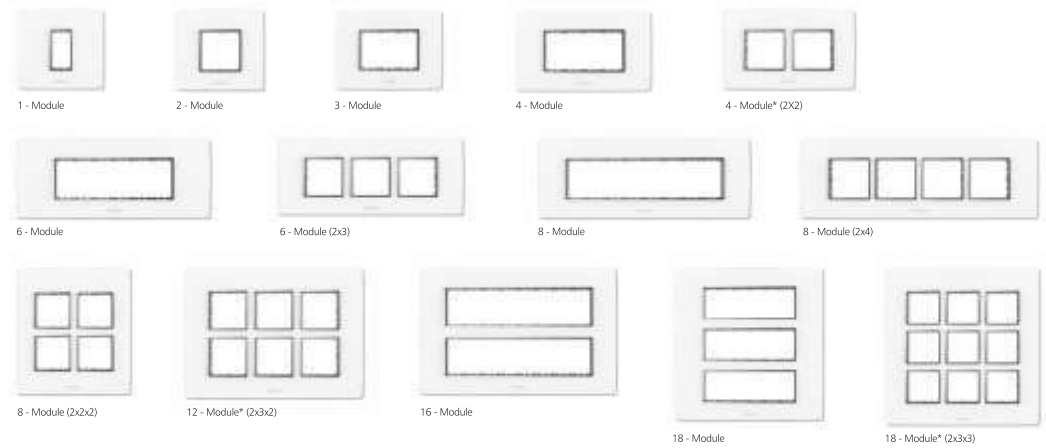

### A5 MOUNTING FRAMES - Horizontal & Vertical Distance for Screwing [ Dimensions in mm ]

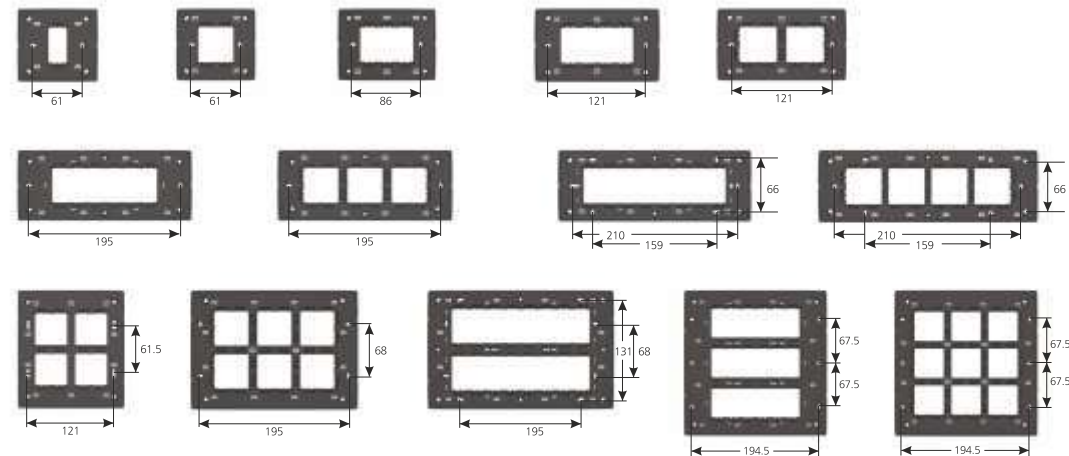



Air A7 Papaya Passion Plate with Carbon Grey Wi-Fi Switch, Regulator

## A7

The AIR A7 cover plate is a wonderful combination of contemporary minimalistic design and stylish elegance. This is an ultra-flat plate with softly rounded corners and sleek chrome border around the inner frame. Characterised by AIR's familiar austere yet charming looks, the A7 offers a quiet and reserved presence without appearing mundane or boring. A quintessential modern-day switch plate, the A7 adds a touch of luxury with convincing functionality to every setting.

Air A7 Titanium Tint Plate With Carbon Grey Aero Switch, Step Marker



### A7 PREMIUM COVER PLATES WITH MOUNTING FRAMES

PLATES →	1M	2M	3M	3M*	4M	4M*	6M	6M*	8M	8M*	8M*	12M*	16M	18M*
						(H&V)**		(H&V)**		(H&V)**	(V)**	(H&V)**	(H&V)**	(H&V)**
COLOURS ↓	MRP ₹	MRP ₹	MRP ₹	MRP ₹	MRP ₹	MRP ₹	MRP ₹	MRP ₹	MRP ₹	MRP ₹	MRP ₹	MRP ₹	MRP ₹	MRP ₹
Pure Glossy	96.00	96.00	126.00	126.00	156.00	156.00	236.00	219.00	325.00	290.00	290.00	354.00	396.00	426.00
Metallic	125.00	125.00	159.00	159.00	197.00	197.00	299.00	277.00	407.00	363.00	363.00	443.00	501.00	568.00
Wood	165.00	165.00	206.00	206.00	254.00	254.00	396.00	366.00	527.00	470.00	470.00	582.00	651.00	727.00
Marble	173.00	173.00	216.00	216.00	268.00	268.00	415.00	384.00	554.00	494.00	494.00	611.00	683.00	763.00
CODE →	230101	230201	230301	230303	230401	230403	230601	230603	230801	230803	238803	231203	231603	231803
Outer/Master →	10/500	10/500	10/400	10/400	10/400	10/400	5/200	5/200	5/200	5/200	5/200	5/120	5/90	5/80
SIZE(mm) →	98x91	98x91	123x91	123x91	152x91	152x91	225x91	225x91	250x91	275x91	152x168	225x158	275x158	225x225

\* With Partition Plates

\*\*Suitable for Horizontal & Vertical Installation

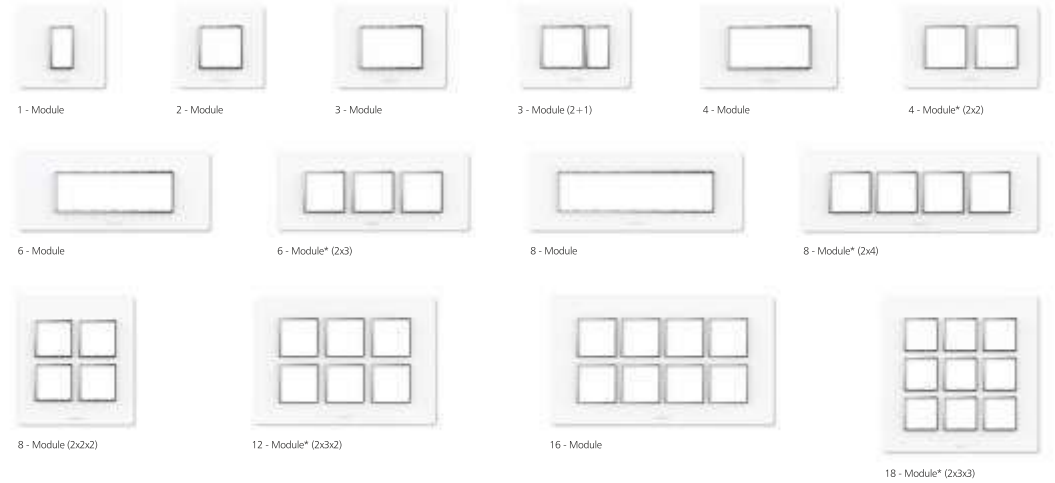

### A7 MOUNTING FRAMES - Horizontal & Vertical Distance for Screwing [ Dimensions in mm ]

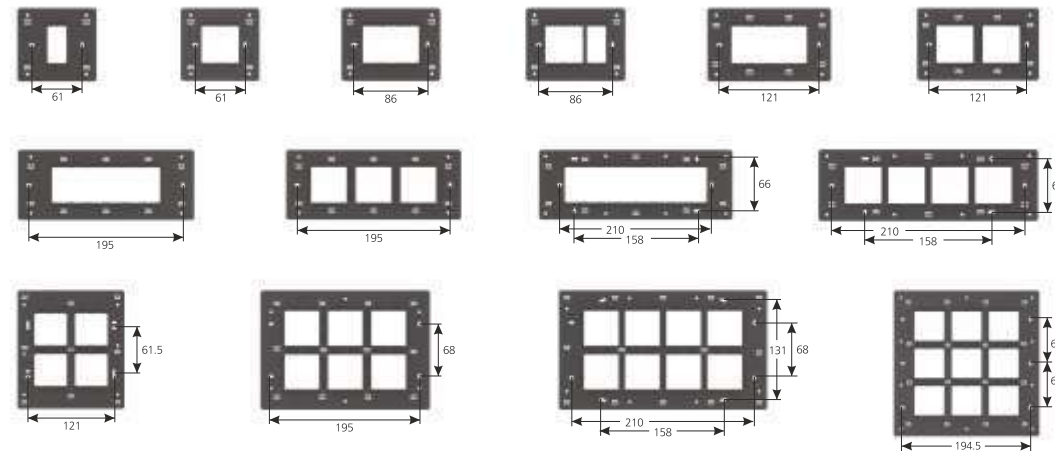

### A6 WOODEN MODULAR PLATES - SUITABLE FOR WOODEN & METAL BOXES

PLATES	1M	2M	3M	4M	4M*	6M	6M*	6M	8M*
					(H&V)**		(H&V)**		(V)
COLOURS	MRP ₹	MRP ₹	MRP ₹	MRP ₹	MRP ₹	MRP ₹	MRP ₹	MRP ₹	MRP ₹
Pure Glossy	116.00	116.00	144.00	195.00	175.00	269.00	250.00	269.00	321.00
Metallic	168.00	168.00	208.00	281.00	253.00	389.00	362.00	389.00	464.00
Wood	235.00	235.00	294.00	396.00	356.00	549.00	513.00	549.00	659.00
CODE	190101	190201	190301	190401	190403	190601	190603	190605	198803
Outer/Master	10/300	10/300	10/300	10/240	10/240	10/200	10/200	10/200	5/200
SIZE(inch)	4.5x4.5	4.5x4.5	4.5x4.5	4.5x6.5	4.5x7.5	4.5x8.5	4.5x8.5	4.5x8.5	6.5x6.5
Module Format	-	-	-	-	2x2	-	2x3	3x2	2x2x2

\* With Partition Plates      \*\*Suitable for Horizontal & Vertical Installation

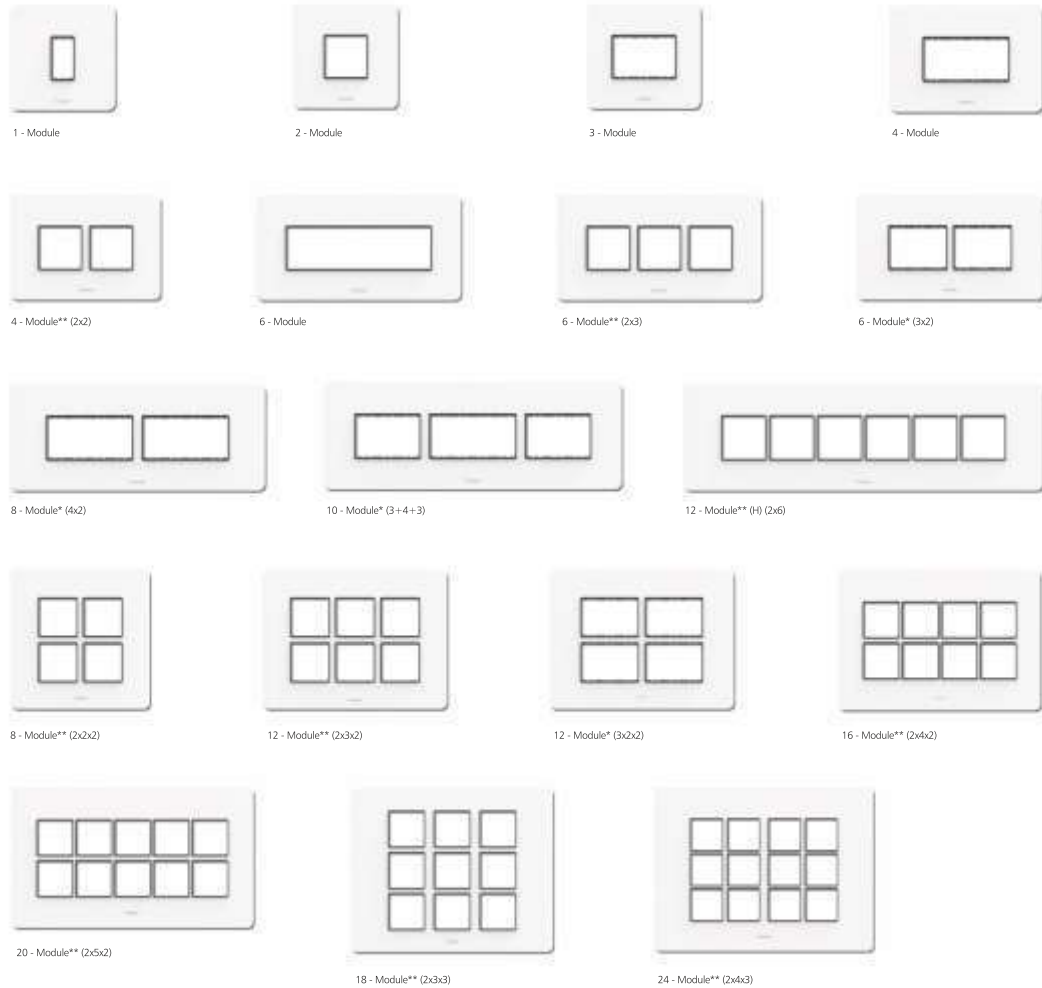

### A6 WOODEN MODULAR PLATES - SUITABLE FOR WOODEN & METAL BOXES

8M*	10M	12M*	12M	12M	16M*	18M*	20M*	24M*
	(H)*	(H&V)**	(V)**	(V)*	(H&V)**	(H&V)**	(H&V)**	(H&V)**
MRP ₹	MRP ₹	MRP ₹	MRP ₹	MRP ₹	MRP ₹	MRP ₹	MRP ₹	MRP ₹
321.00	376.00	423.00	483.00	423.00	510.00	542.00	678.00	837.00
464.00	544.00	611.00	699.00	611.00	738.00	783.00	979.00	1210.00
659.00	767.00	868.00	987.00	868.00	1046.00	1103.00	1386.00	1718.00
190805	191001	191201	191203	191205	191601	191801	192001	192401
10/200	10/120	10/120	5/120	5/120	5/90	5/80	5/60	5/40
4.5x10.5	4.5x12.5	4.5x15.5	6.5x8.5	6.5x8.5	7.5x10.5	8.5x10.5	7.5x12.5	9.5x12.5
4x2	3+4+3	2x6	2x3x2	3x2x2	2x4x2	2x3x3	2x5x2	2x4x3

\* With Partition Plates      \*\*Suitable for Horizontal & Vertical Installation

### A6 MOUNTING FRAMES - Horizontal & Vertical Distance for Screwing ( Dimensions in mm )

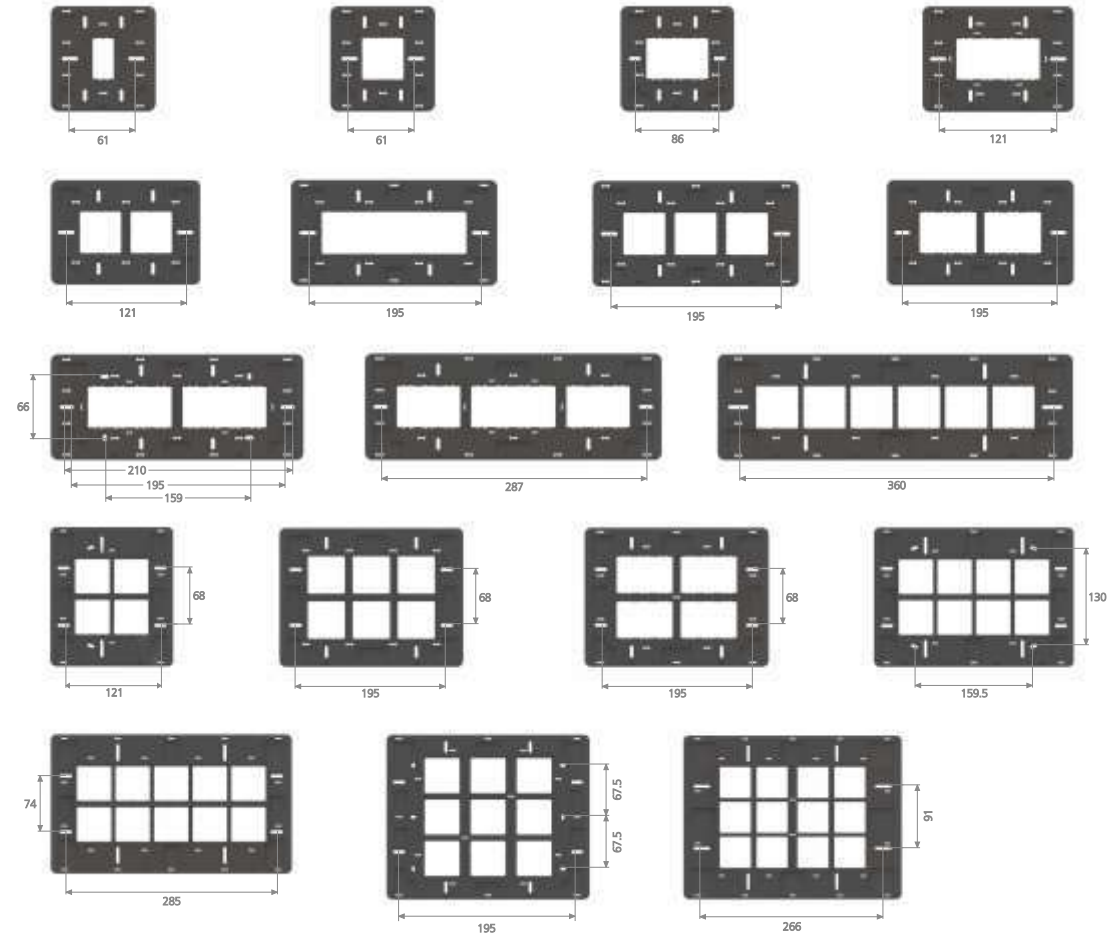

# Not Suitable for Metal Box



Define your world with colours

**A3**  
PLATES

PURE GLOSSY



01 - Absolute White

METALLIC



02 - Carbon Grey



03 - Orchid Fusion

**A5**  
PLATES

BASIC - PURE GLOSSY



01 - Absolute White

**A7**  
PLATES

PREMIUM - PURE GLOSSY



01 - Absolute White

METALLIC



02 - Papaya Passion



03 - Titanium Tint



04 - Terracotta

WOOD



05 - Espresso Wenge

MARBLE



06 - Smoky Marble

**A6**  
PLATES

PREMIUM - PURE GLOSSY



01 - Absolute White

METALLIC



07 - Carbon Grey



08 - Quantum Blue

WOOD



21 - Volcanic Ash\*



22 - Coffee Magic



23 - Wild Wenge

\* introducing shortly

Colours shown may not match actual product colours due to printing limitations

Powering your  
switchboard.  
safely.



## FLUSH MOUNTING METAL GANG BOX

Compact, resilient and sturdy, the Goldmedal metal gang boxes are the ideal enclosures for your switchboard accessories. Available in galvanized and 304 grade stainless steel options, these metal gang boxes securely hold all electrical wires and components in place without any additional support. While the galvanized metal boxes are corrosion-resistant, the stainless steel metal boxes are rust-free, easy to clean, and extremely strong and durable. With their simple yet robust design, these mounting boxes play a passive but invaluable role in ensuring that your electrical devices perform to their optimum without any interruption!

### ECO FLUSH MOUNTING METAL GANG BOXES (GALVANIZED)

GANG BOX →	1 & 2M	3M	4M	6M	8M(H)	8M(V)	12M	16M	18M
MRP ₹ ↓	83.00	106.00	131.00	164.00	214.00	214.00	268.00	328.00	377.00
CODE	310201	310302	310403	310604	310805	318806	311207	311608	311809
Outer/Master	10/120	10/120	10/120	5/80	5/80	5/60	5/45	5/40	5/40
SIZE (LxWxH) mm	75x73x52	100x73x52	136x73x52	208x73x52	232x78x54	135x130x60	209x130x60	233x145x60	209x200x60

#### METAL GANG BOXES



### PREMIUM FLUSH MOUNTING GANG BOXES (STAINLESS STEEL) NEW

GANG BOX →	1 & 2M	3M	4M	6M	8M(H)	8M(V)	12M	16M	18M
MRP ₹ ↓	194.00	244.00	302.00	378.00	492.00	492.00	618.00	758.00	866.00
CODE	320201	320302	320403	320604	320805	328806	321207	321608	321809
Outer/Master	10/120	10/120	10/120	5/80	5/80	5/60	5/45	5/40	5/40
SIZE (LxWxH) mm	75x73x52	100x73x52	136x73x52	208x73x52	232x78x54	135x130x60	209x130x60	233x145x60	209x200x60

#### STAINLESS STEEL GANG BOXES

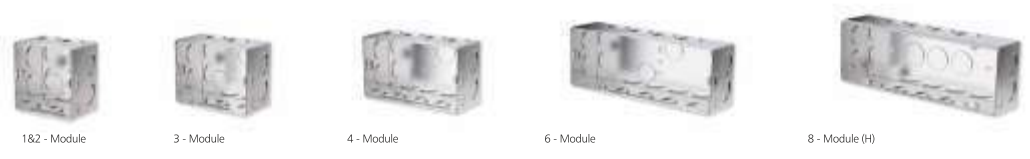

**FLUSH MOUNTING METAL GANG BOXES (GALVANIZED)**

GANG BOX →	1 & 2M	3M	4M	6M	8M(H)	8M(V)	12M	16M	18M
MRP ₹ ↓	97.00	122.00	151.00	189.00	246.00	246.00	309.00	379.00	433.00
CODE	70201	70302	70403	70604	70805	78806	71207	71608	71809
Outer/Master	10/120	10/120	10/120	5/80	5/80	5/60	5/45	5/40	5/40
SIZE (LxWxH) mm	75x73x52	100x73x52	136x73x52	208x73x52	232x78x54	135x130x60	209x130x60	233x145x60	209x200x60

**METAL GANG BOXES**

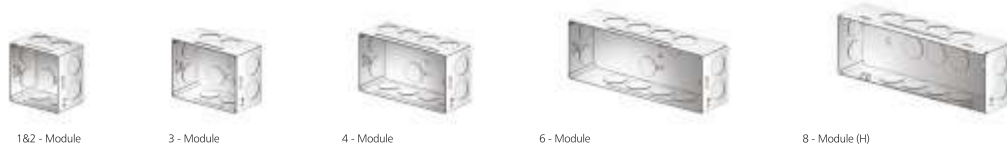

**FLUSH MOUNTING PLASTIC GANG BOXES (FIRE RESISTANT)**

GANG BOX →	1 & 2M	3M	4M	6M	8M(H)	8M(V)	12M	16M	18M
MRP ₹ ↓	83.00	95.00	113.00	149.00	179.00	179.00	236.00	277.00	337.00
CODE	80201	80302	80403	80604	80805	88806	81207	81608	81809
Outer/Master	10/120	10/120	10/120	5/80	5/80	5/60	5/45	5/40	5/40
SIZE (LxWxH) mm	79x82x50	104x82x50	139x82x50	213x82x50	263x86x55	141x142x55	213x143x55	249x150x55	214x211x58

**PLASTIC GANG BOXES**

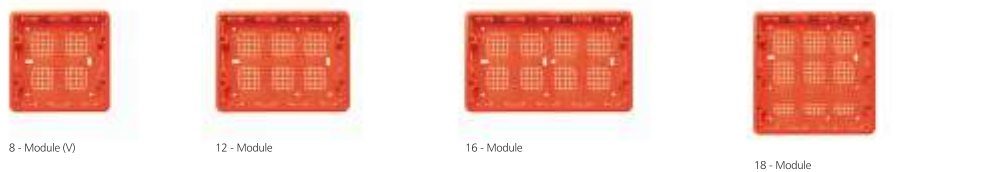
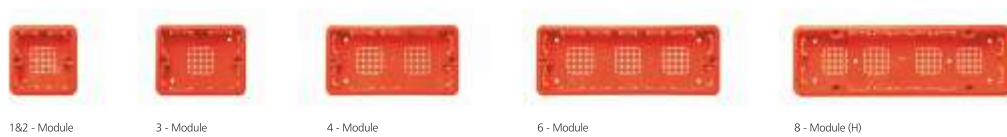

**SURFACE MOUNTING PLASTIC GANG BOXES (FIRE RESISTANT)**

GANG BOX →	1 & 2M	3M	3M	4M	6M	8M(H)	8M(V)	12M	16M	18M
MRP ₹ ↓	81.00	117.00	117.00	125.00	157.00	201.00	201.00	255.00	285.00	338.00
CODE	90201	90302	93303	90404	90605	90806	98807	91208	91609	91810
Outer/Master	10/120	10/120	10/120	10/120	5/80	5/80	5/60	5/45	5/40	5/40
SIZE (LxWxH) mm	92x85x48	124x85x48	118x85x48	150x85x48	218x85x48	267x85x48	153x154x48	219x154x48	267x154x48	224x227x48

**PLASTIC SURFACE GANG BOXES**

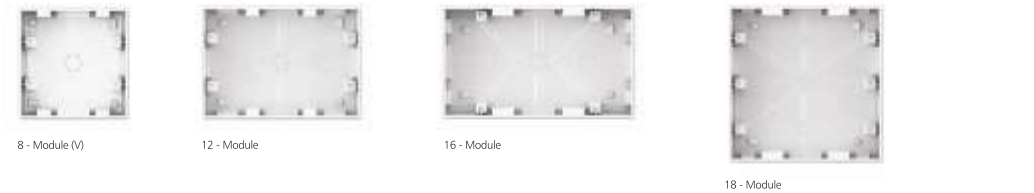

**G- SURFACE MOUNTING PLASTIC GANG BOXES (FIRE RESISTANT) Suitable for Grazia & Classico**

GANG BOX →	1 & 2M	3M	4M	4M (HV)	6M	8M(H)	8M(HV)	8M (V)	9M	12M	16M	18M
MRP ₹ ↓	88.00	133.00	147.00	147.00	184.00	241.00	241.00	241.00	272.00	297.00	345.00	401.00
CODE	100201	100302	100403	100404	100605	100806	100807	108808	100909	101212	101611	101812
Outer/Master	10/120	10/120	10/120	10/120	5/80	5/80	5/80	5/60	5/80	5/45	5/40	5/40
SIZE (LxWxH) mm	91x89x48	119x89x48	145x89x48	150x89x48	218x89x48	243x89x48	263x89x48	154x155x48	279x89x48	218x155x48	243x155x48	218x222x48

**PLASTIC SURFACE GANG BOXES**

Note: Not suitable for Grazia 8M (V) Plate



Say goodbye to dull,  
boring doorbells.



THE ULTIMATE  
STAR OF  
YOUR DECOR.  
**STAR SPACE**

ANNOUNCE  
YOUR  
GUESTS IN STYLE!  
**GALAXY**



STYLISH HOMES  
DESERVE STYLISH  
WELCOMES.  
**ALPHA**

DISTINCTIVE  
LOOKS.  
REMARKABLE  
SOUND.  
**SOUND<sup>9</sup>**



More reasons to  
welcome with a smile!



ZOOMBA AND  
ZOOMBA PLUGIN BELL

REMOTE



ZOOMBA  
PLUGIN BELL  
THE CIRCULAR  
SYMPHONY.

GROOVE WITH  
EVERY BUZZ!

ZOOMBA



EXQUISITE  
SOUND  
ON EVERY RING.

EXO



GET, SET,  
PLUG AND RING!

ULTRA

ULTRA AND  
EXO PLUGIN BELL

REMOTE



Sleek sounds for modern homes.



MAKE WARM WELCOMES WARMER!













POLYGON

HERE THEY ALL COME TOGETHER

BUZY BEE

ADD ANOTHER DIMENSION TO YOUR FOUR WALLS.

GHEXO

Code	Item	MRP ₹	Pkg.	Outer/Master		
<b>ELECTRONIC DOOR BELL</b>						
204061	<b>G-Shell</b> Polyphonic With Selectable Tunes & Flashing Light, 2 Mode Selection, Ding Dong Melody & English Multitune - 17 Melodies	449.00	5/60			
				204061	204062	204063
204062	<b>G-Space</b> Polyphonic 4 Mode Selection, Big Ben Chime & Pod, Amitabh Song Tunes & Pod - 18 Melodies Big Ben Chime, Amitabh Song Tunes - 18 Melodies	540.00	5/60			
204063	<b>G-Hexo</b> 4 Mode Selection, Hindi Multitune - 8 Melodies, English Multitune - 8 Melodies, Ding Dong Melody, Big Ben Chime	496.00	5/60			
204064	<b>G-Oxi</b> Polyphonic with selectable tunes & flashing light 4 mode selection, Big Ben chime, Hindi multitune, & POD - 20 melodies, Hindi multitune & POD - 26 melodies, Hindi multitune - 20 melodies	566.00	5/60			
				204064	204065	204066
204065	<b>Buzy-Bee</b> Polyphonic 4 Mode Selection, Big Ben Chime & Pod, Amitabh Song Tunes & Pod - 18 Melodies Big Ben Chime, Amitabh Song Tunes - 18 Melodies	642.00	5/60			
204066	<b>G-Astro</b> Polyphonic With Selectable Tunes & Flashing Light, 4 Mode Selection, Hindi Multitune - 8 Melodies, English Multitune - 8 Melodies, Ding Dong Melody, Big Ben Chime	513.00	5/60			
				204067	204069	
204067	<b>Polygon</b> Single Tune - Ding Dong melody	401.00	5/60			
204069*	<b>Zoomba</b> 32 selectable melodies, Flashing Light, Volume Control & Tune selection Function.	-	-			
204070	<b>Welcome</b> Piano Tunes With Flashing Light Hindi Multitune & Pod - 24 Melodies	525.00	5/60			
				204070	204072	
204072	<b>Pulse</b> Piano Tunes With Flashing Light English Multitune & Pod - 18 Melodies	525.00	5/60			
204078	<b>Zyro (Mp3 Door Bell)</b> In-built 128 Mb Storage, Pre-recorded Tunes And Melodies, Volume Control & Shuffle Function Customize & Store Your Own Music. (Supplied With Usb Cable For File Transfer)	1390.00	5/60			
204082	<b>Red Dot</b> Polyphonic With Selectable Tunes & Flashing Light Volume Control & Shuffle Function 4 Mode Selection, Hindi Multitune - 20 Melodies, Hindi Multitune & Pod - 20 Melodies Fur Elis E Piano Tune, Big Ben Chime	642.00	5/60			
				204078	204082	
204083	<b>Salsa</b> Polyphonic With Selectable Tunes & Flashing Light 4 Mode Selection, Hindi Multitune-20 Melodies, & Pod, Big Ben Chime, Hindi Multitune With Pod - 26 Melodies, Hindi Multitune-20 Melodies	607.00	5/60			
						204083
* introducing shortly						



Code	Item	MRP ₹	Pkg.
Outer/Master			
<b>ELECTRONIC DOOR BELL</b>			
204501*	Sound <sup>9</sup> Push & Select Function with Flashing LED Light, English Multitone - 16 Melodies, Polyphonic Tunes	-	5/60
204502	Alpha Push-Select Function With Flashing Light, Ding Dong Melodies, Big Ben Chime & English Piano Tune, 3 Polyphonic Tunes	492.00	5/60
204503	Galaxy Slide & Select Function With Flashing Light, Ding Dong Melodies, Big Ben Chime & English Piano Tune, 3 Polyphonic Tunes	514.00	5/60
204504	Edge Polyphonic Polyphonic With Selectable Tunes & Flashing Light 2 Mode Selection Hindi Multitones & Pod - 28 Melodies, Big Ben Chime	459.00	5/60
204507	Star Space Piano tune - English single tune	524.00	5/60
<b>DING DONG DOOR BELL</b>			
203048	Ocean Stereophonic Ding Dong	249.00	5/100
203049	Aqua Stereophonic Ding Dong	249.00	5/100
203050	Snowwhite Stereophonic Ding Dong	247.00	5/100
203051	Belaton Stereophonic Ding Dong	249.00	5/100
203052	Woofer Stereophonic Ding Dong	304.00	5/100
203053	G-Spot Stereophonic Ding Dong	298.00	5/100
203054	Prism Stereophonic Ding Dong	239.00	5/100
203055	Chimex Stereophonic Ding Dong	499.00	5/60
GL422	Angel Ding Dong Bell	240.00	5/150
<b>ELECTRONIC BIRD CHIME BELL</b>			
GL461	Cuckoo Bird Chime	363.00	5/60
GL462	Parrot Bird Chime	371.00	5/100
GL464	Buzzer	81.00	10/300
GL465	Mini Parrot Bird Chime	317.00	10/120
* introducing shortly			

Code	Item	MRP ₹	Pkg.
Outer/Master			
<b>MANTRA DOOR BELL</b>			
204079	Ek Mantra - Gayatri Mantra	410.00	5/90
204080A	Ekaant - Mantra Bell with 4 selectable mantras & flashing light (4 mode selection - Jain Stuti, Gurubani, Maha Laxmi & Tirupati Balaji Mantra)	513.00	5/60
204080B	Ekaant - Mantra Bell with 4 selectable mantras & flashing light (4 mode selection - Guru Mantra, Maha Mritunjaya, Ganeshi & Sainath Mantra)	513.00	5/60
204080C	Ekaant - Mantra Bell with 4 selectable mantras & flashing light (4 mode selection - Sri Krishna, Ding Dong, Azaan & Gayatri Mantra)	513.00	5/60
204080D	Ekaant Polyphonic With 4 Selectable Tune & Flashing Light	513.00	5/60
<b>WIRELESS PLUG-IN DOOR BELL</b> <span style="color: red;">NEW</span>			
204505	Exo Plug-In Wireless Bell with Remote, 32 Selectable Melodies, Play-Pause, Forward-Reversed Volume Control Function Direct AC Power (No Battery Required for Bell, Battery Required Only for Remote)	1300.00	5/60
204506	Ultra Plug-In Wireless Bell with Remote, Single Ding-Dong Melody, Play-Pause Function Direct AC Power (No Battery Required for Bell, Battery Required Only for Remote)	1200.00	5/60
207212*	Zoomba Plugin With Remote Wireless Bell With Remote, 32 Selectable Melodies, Flashing Light, Volume Control & Tune Selection Function. Direct AC Power (No Battery Required For Bell, Battery Required Only For Remote)	-	-
207213*	Zoomba With Remote Wireless Bell With Remote, 32 Selectable Melodies, Flashing Light, Volume Control & Tune Selection Function. (Battery Required For Bell & Remote)	-	-
<b>ALARM BELLS</b>			
207202	Liquid Water Alarm Bell Single Tune Water Alarm Sound With Flashing Led Light	704.00	1/60
<b>DOOR BELLS DISPLAY BOARD</b> <span style="color: red;">NEW</span>			
207301*	Door Bell Display Board	-	-
* introducing shortly			

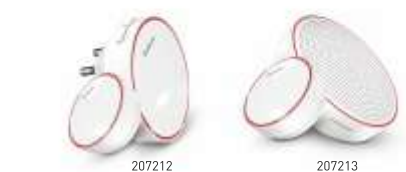

# Power, Freedom and Style.



i-Strip LED 6x1 Spike Guard with Surge Protector

## Curve plus

Enjoy real convenience and real freedom by connecting your electrical appliances to where you are – whether it's for work, entertainment or household chores. Available in various design options with the flexibility to connect national and international plugs, these spike guards and power strips ensure you always stay connected and on. So go ahead, unwind and connect everything you need.

i-Grip LED Spike Guard with USB



i-Strip LED 4x1 Spike Guard with Surge Protector



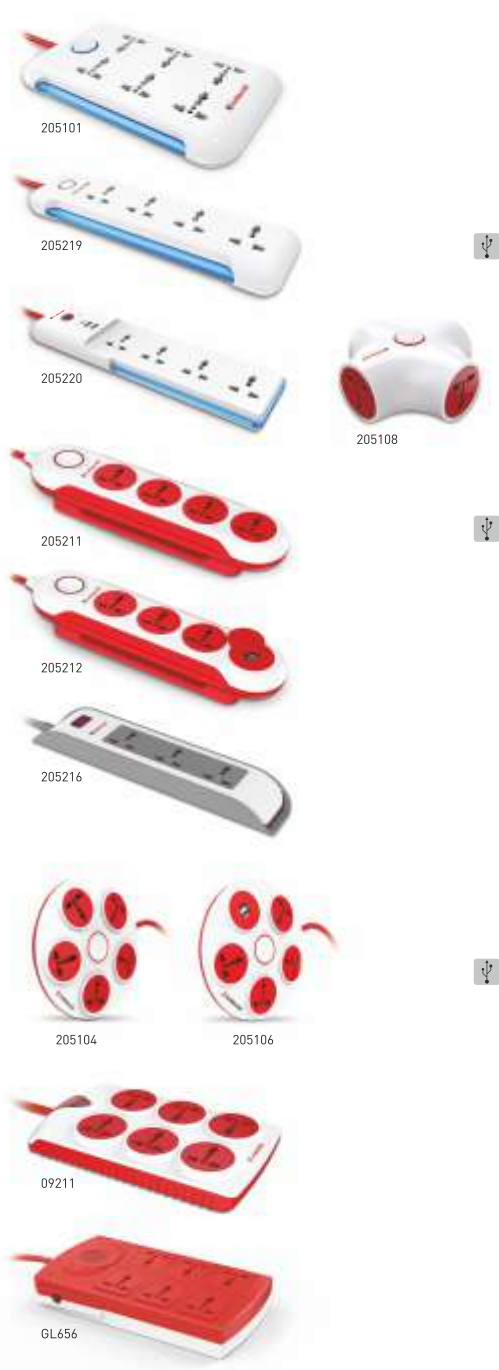

Code	Item	MRP ₹	Pkg.
			Outer/Master
<b>HIGH GRADE ADAPTORS SPIKE GUARD 240V~</b>			
205101	i-Strip LED Spike Guard 6 Outlet International Socket, Master Switch, Indicator With Surge Protector & Reset Switch - 2 Mtr Cable	1243.00	-/30
205219*	i-Strip LED Spike Guard <b>NEW</b> 4 Outlet International Socket, Master Switch, Indicator With Surge Protector & Reset Switch - 2 Mtr Cable	-	-/30
205220*	i-Grip LED Spike Guard <b>NEW</b> 4 Outlet International Socket, USB Port Total USB OUTPUT (A+A+C): 30Watt Max. With Master Switch & Indicator With Surge Protector & Reset Switch 2 Mtr Cable	-	-/30
205108	G-Trix 4x1 Spike Guard 4 Outlet International Socket, Master Switch With Indicator & Reset Switch With Surge Protector - 2 Mtr Cable	689.00	5/30
205211	G-Xpress 4x1 Spike Guard 4 Outlet International Socket With Master Switch With Indicator & Reset Switch - 2 Mtr Cable	790.00	-/30
205212	G-Xpress 4x1 Spike Guard with USB 3 Outlet International Socket, Dual USB Port - Output 2100mA, Master Switch With Indicator & Reset Switch - 2 Mtr Cable	1299.00	-/30
205216	Taco 3x1 Spike Guard <b>NEW</b> 3 Outlet International Sockets & Master Switch With Indicator & Reset Switch With Surge Protector - 2 Mtr Cable	631.00	-/30
<b>360° HIGH GRADE ADAPTORS 240V~</b>			
205104	360° Spike Guard 5 Outlet International Socket, Master Switch With Indicator & Reset Switch With Surge Protector - 2 Mtr Cable	886.00	-/30
205106	360° Spike Guard with USB 4 Outlet International Socket, Dual USB Port - Output 2100mA, Master Switch With Indicator & Reset Switch - 2 Mtr Cable	1177.00	-/30
<b>ESSENZA SPIKE GUARD 240V~</b>			
09211	Plugged-IN 6x1 Spike Guard 6 Outlet International Sockets, Master Switch With Indicator & Reset Switch With Surge Protector - 2 Mtr Cable	1095.00	-/30
<b>SPIKE GUARD 240V~</b>			
GL656	6 Outlet Spike Adapter with Switch & Lamp   surge & spike protection with international socket outlet & reset switch	936.00	5/40

Code	Item	MRP ₹	Pkg.
			Outer/Master
<b>POWER STRIP 240V~ / USB CHARGER</b>			
205103	i-Design 4x4 Power Strip 4 Outlet International Socket With Individual Switch & Indicator - 2 Mtr Cable	1089.00	-/30
205107	i-Design 4x4 Power Strip with USB 3 Outlet International Socket, Dual USB Port - Output 2100mA. With Individual Switch & Indicator - 2 Mtr Cable	1497.00	-/30
205114	Ninja 3+1 Power Strip <b>NEW</b> 3 Outlet International Sockets, 2 Pin Socket With Indicator - 2 Mtr Cable  (Can Also Be Used With Ninja USB Charger)	599.00	-/60
205115	Ninja 25W USB Charger <b>NEW</b> Dual USB Port (Type-C & Type-A)  (Can Be Used Either With Ninja Power Strip Or As A Separate Product)	750.00	10/120
<b>360° POWER STRIP 240V~</b>			
205100	360° Power Strip 6 Outlet International Socket, Master Switch With Indicator - 2 Mtr Cable	886.00	-/30
<b>ESSENZA POWER STRIP 240V~</b>			
09207	Plugged-IN 4x4 Power Strip with USB 3 Outlet International Sockets & Dual USB Charger, Individual Switch With Indicator - 2 Mtr Cable	1338.00	-/30
09208	Plugged-IN 4x1 Power Strip 4 Outlet International Sockets, Master Switch With Indicator - 2 Mtr Cable	748.00	-/30
09209	Plugged-IN 4x4 Power Strip 4 Outlet International Sockets, Individual Switch With Indicator - 2 Mtr Cable	1025.00	-/30
09210	Plugged-IN 4x1 Power Strip 4 Outlet International Sockets, Master Switch With Indicator - 5 Mtr Cable	1200.00	-/30
<b>POWER STRIP 240V~</b>			
GL655	4 Outlet Power Strip (with international socket outlet	615.00	5/60

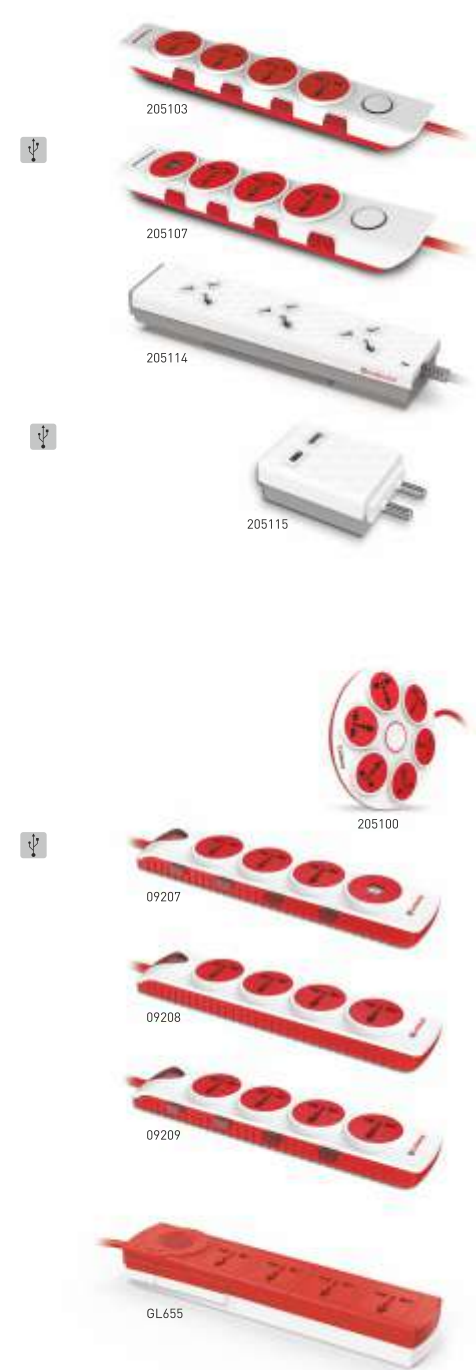

# Connecting devices. Safeguarding lives.

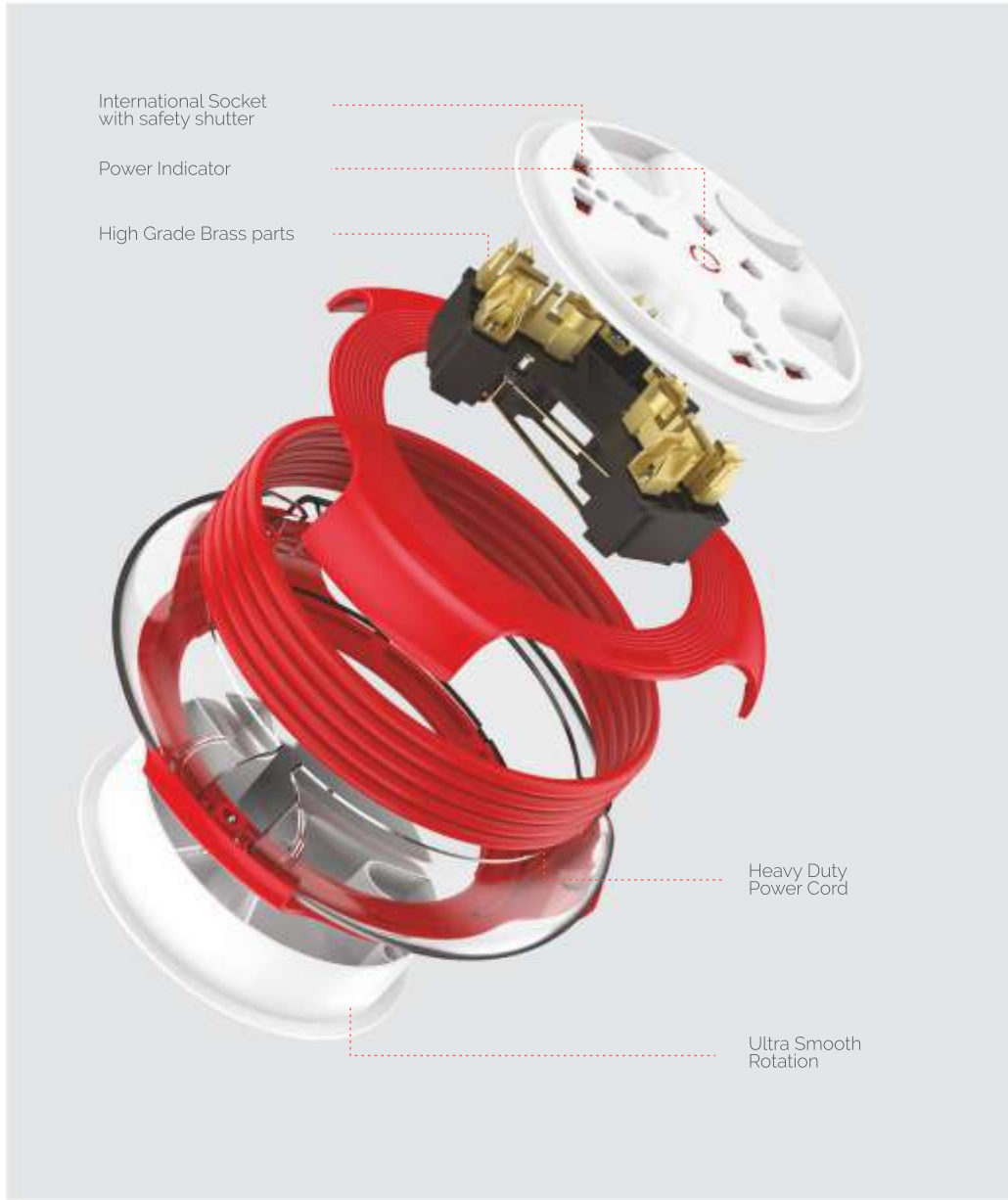

Code	Item	MRP ₹	Pkg.
			Outer/Master
<b>2 PIN EXTENSION CORD WITH HANDLE</b>			
205116	Sliq 2 Pin With Handle - Master Switch With Indicator, International Socket & 2 Pin Sockets - 5 Mtr Cable	473.00	-/60
205118	Quord 2 Pin With Handle- Master Switch With Indicator, International Socket & 2 Pin Sockets - 5 Mtr Cable	476.00	-/60
205126	G-Expert 2 Pin With Handle - Master Switch With Indicator, International Socket & 2 Pin Sockets - 5 Mtr Cable	476.00	-/60
<b>3 PIN EXTENSION CORD WITH HANDLE</b>			
205117	Sliq 3 Pin With Handle - Master Switch With Indicator, International Socket & 2 Pin Sockets - 4 Mtr Cable	603.00	-/60
<b>2 PIN EXTENSION CORD WITHOUT HANDLE</b>			
205120	Dazzle 2 Pin Master Switch With Indicator, International Socket & 2 Pin Sockets - 5 Mtr Cable	453.00	-/60
205124	G-Smart 2 Pin Master Switch With Indicator, International Socket & 2 Pin Sockets - 5 Mtr Cable	460.00	-/60
205135	Krysta 2 Pin Master Switch With Indicator, International Sockets & 2 Pin Socket - 5 Mtr Cable	540.00	-/60
205138	Plano 2 Pin Master Switch With Indicator, International Socket & 2 Pin Sockets - 5 Mtr Cable	486.00	-/60
205142*	Vyro 2 Pin <span style="color:red">NEW</span> Master Switch With Indicator, International Socket & 2 Pin Sockets - 5 Mtr Cable	457.00	-/60
<b>3 PIN EXTENSION CORD WITHOUT HANDLE</b>			
205134	Gio 3 Pin 2 International Socket With Indicator, - 1.5 Mtr Cable	460.00	-/60
205137*	Beat 3 Pin <span style="color:red">NEW</span> 2 International Socket - 5 Mtr Cable	-	-/60
	* introducing shortly		

Code	Item	MRP ₹	Pkg.
			Outer/Master
<b>HIGH GRADE 16A EXTENSION CORD</b>			
205131	Twister 16A 3 Pin Master Switch With Indicator, 6/16A Uni. Socket, International Socket & 2 Pin Socket - 3.5 Mtr Cable	1078.00	-/30
205132	G-Expert 16A 3 Pin With Handle - Master Switch With Indicator, 6/16A Uni. Socket, International Socket & 2 Pin Socket & Tripper - 3.5 Mtr Cable	1149.00	-/30
<b>DECORATIVE WIRE LINK</b>			
205149	Decorative Wire Link With 2 Pin Plug & Pendant Holder - 5 Mtr Cable	243.00	-/60
<b>ESSENZA EXTENSION CORDS 240V-</b>			
09201	Flexi 2 Pin Master Switch With Indicator, International Socket & 2 Pin Sockets - 5 Mtr Cable	450.00	-/60
09202	Flexi 2 Pin Master Switch With Indicator, International Socket & 2 Pin Sockets - 8 Mtr Cable	570.00	-/60
<b>EXTENSION CORDS 240V-</b>			
GL403	Round 2 Pin - 4 Mtr.	430.00	5/80
GL404	Round 2 Pin - 8 Mtr.	560.00	5/80
	Images are for illustrative purposes only. Actual product may vary.		





206151

206152

Code	Item	MRP ₹	Pkg.
Outer/Master			
<b>LED NIGHT LAMPS</b>			
206151	Hot Shot Night Lamp with LED	107.00	10/300
206152	Desire Night Lamp with LED	97.00	10/300
Available colour: Blue, Yellow & Orange			



206161

206162

206163

<b>EDGE GLOW LED / NIGHT LAMPS</b>			
206161	Divine Glow - Shri Parashwanath Edge Glow LED Night Lamp	155.00	10/300
206162	Divine Glow - Lord Ganesha Edge Glow LED Night Lamp	155.00	10/300
206163	Divine Glow - Maha Laxmi Edge Glow LED Night Lamp	155.00	10/300
206164	Divine Glow - Tirupati Balaji Edge Glow LED Night Lamp	155.00	10/300
206165	Divine Glow - Guru Nanak Edge Glow LED Night Lamp	155.00	10/300
206166	Divine Glow - Azaan Edge Glow LED Night Lamp	155.00	10/300
206169	G-Focus Night Lamp With LED	243.00	10/300
206170A*	G-Divine Shri Parashwanath Edge Glow LED Night Lamp	190.00	5/100
206170B*	G-Divine Lord Ganesha Edge Glow LED Night Lamp	190.00	5/100
206170C*	G-Divine Maha Laxmi Edge Glow LED Night Lamp	190.00	5/100
206170D*	G-Divine Tirupati Balaji Edge Glow LED Night Lamp	190.00	5/100
206170E*	G-Divine Guru Nanak Edge Glow LED Night Lamp	190.00	5/100
206170F*	G-Divine Azaan Edge Glow LED Night Lamp	190.00	5/100



203164

203165

206169



206170 A

206170 B

206170 C



206170 D

206170 E

206170 F



06326

06330

06331

<b>SELF ADHESIVE PVC ELECTRICAL INSULATION TAPE</b>			
06326	PVC Electrical Insulation Tape (6mtr) Size: 0.125mm x 17mm x 6mtr.	18.00	30/1200
06330	PVC Electrical Insulation Tape (15mtr) Size: 0.125mm x 17mm x 15mtr. <b>NEW</b>	47.00	16/256
06331	PVC Electrical Insulation Tape (25mtr) Size: 0.125mm x 17mm x 25mtr. <b>NEW</b>	57.00	10/240

\* introducing shortly

The power to shape your world.



Powergrip Plug Top  
LDS System, Easy & Safe Grip



Spice 3 Pin Universal  
Travel Adaptor  
With Indicator



Groove Plug Top  
LDS System, Easy & Safe Grip



Beetle Plug Top  
LDS System, Easy & Safe Grip



Code	Item	MRP ₹	Pkg.
<b>PLUG TOPS 240V~</b>			
202023	Zap 6A 2 Pin Plug LDS System, Easy & Safe Grip	40.00	25/1200
202025	Zap 6A 2 Pin Male Female LDS System, Easy & Safe Grip	69.00	25/800
202026	Avian 6A 3 Pin Plug LDS System, Easy & Safe Grip	89.00	20/600
202027	Avian 16A 3 Pin Plug LDS System, Easy & Safe Grip	118.00	10/300
202028	Fusion 6A 3 Pin Plug LDS System, Easy & Safe Grip	92.00	20/600
202029	Fusion 16A 3 Pin Plug LDS System, Easy & Safe Grip	122.00	10/300
202030	G-grip 6A 3 Pin Plug with LED LDS System, Easy & Safe Grip	103.00	20/600
202031	G-grip 16A 3 Pin Plug with LED LDS System, Easy & Safe Grip	126.00	10/300
202071	Powergrip 6A 3 Pin Plug LDS System, Easy & Safe Grip	95.00	20/600
202072	Powergrip 16A 3 Pin Plug LDS System, Easy & Safe Grip	128.00	10/300
202073	Groove 6A 3 Pin Plug LDS System, Easy & Safe Grip	94.00	20/600
202074	Groove 16A 3 Pin Plug LDS System, Easy & Safe Grip	127.00	10/300
202075	Beetle 6A 3 Pin Plug LDS System, Easy & Safe Grip	93.00	20/600
202076	Beetle 16A 3 Pin Plug LDS System, Easy & Safe Grip	126.00	10/300
<b>3 PIN PLUG TOP</b>			
GL213	Cub 6A 3 Pin Plug	85.00	20/600
GL214	Cub 16A 3 Pin Plug	118.00	10/300
<b>16A PILOT SWITCH / SOC./ ROUND TOP (UREA)</b>			
GL384	16A Surface 3Pin Socket (Round Black)	136.00	10/160
GL385	16A 3 Pin Top (Round Black)	140.00	20/240
<b>UNIVERSAL TRAVEL ADAPTOR 240V~</b>			
202037	i-Link 16A 3 Pin Universal Travel Adaptor With Mobile Socket	242.00	10/120
202039	Sliq 3 Pin Universal Travel Adaptor LDS System, Easy & Safe Grip With Indicator	97.00	20/300
202042	Spice 3 Pin Universal Travel Adaptor With Indicator	165.00	10/300
202043	G-cube 2 Pin Universal Travel Adaptor With Surge Protector	76.00	20/300
202044	G-dot 2 Pin Universal Travel Adaptor With Surge Protector	76.00	20/300
202045	G-cube 2 Pin Universal Travel Adaptor	65.00	20/300
202046	G-dot 2 Pin Universal Travel Adaptor	65.00	20/300

\* Suitable for all kinds of plugs used around the world

Code	Item	MRP ₹	Pkg.
<b>UNIVERSAL TRAVEL ADAPTOR 240V~</b>			
202051*	Surge 3 Pin Universal Travel Adaptor	-	10/300
202052*	Snap 3 Pin Universal Travel Adaptor	-	10/300
<b>ESSENZA LAMP HOLDER / BED SWITCH</b>			
09190	Bed Switch	64.00	20/1200
09191	Skirt Pendant Holder	46.00	30/600
<b>ADAPTOR / SKIRT PENDANT HOLDER (UREA)</b>			
GL195	Adaptor	31.00	30/720
GL206	Skirt Pendant Holder	40.00	30/720
<b>CEILING ROSE 240V~</b>			
201016	Pilot Ceiling Rose Advanced Interlock Configuration	55.00	20/600
201017	Jumbo Ceiling Rose Advanced Interlock Configuration	66.00	20/400
201018	Glassio Ceiling Rose Advanced Interlock Configuration	79.00	20/400

\* introducing shortly



# More ways to power your dreams!



Gzifa Angle Holder  
Advanced interlock configuration

Ecco Angle Holder  
Advanced interlock configuration

Ola Batten Holder  
Advanced interlock configuration

Uber Batten Holder  
Advanced interlock configuration

Code	Item	MRP ₹	Pkg.
Outer/Master			
<b>LAMP HOLDER 240V~</b>			
201001	Oro Angle Holder Advanced Interlock Configuration	83.00	20/400
201002	Oro Batten Holder Advanced Interlock Configuration	83.00	20/400
201003	Ecco Angle Holder Advanced Interlock Configuration	85.00	20/400
201004	Ecco Batten Holder Advanced Interlock Configuration	85.00	20/400
201005	Angle Holder Advanced Interlock Configuration	70.00	20/400
201006	Batten Holder Advanced Interlock Configuration	70.00	20/400
201007	Jumbo Batten Holder Advanced Interlock Configuration	83.00	20/400
201008	Ecco Gama Batten Holder Advanced Interlock Configuration	99.00	20/400
201010	Gzifa Angle Holder Advanced Interlock Configuration	89.00	20/400
201011	Gzifa Batten Holder Advanced Interlock Configuration	89.00	20/400
201012	Oval Angle Holder 4x4 Advanced Interlock Configuration	116.00	10/300
201013	Oval Batten Holder 4x4 Advanced Interlock Configuration	116.00	10/300
201009	Glassio Angle Holder 4x4 Advanced Interlock Configuration	108.00	10/300
201014	Glassio Batten Holder 4x4 Advanced Interlock Configuration	108.00	10/300
201019	Euro Angle Holder 4x4 Advanced Interlock Configuration	124.00	10/300
201020	Euro Batten Holder 4x4 Advanced Interlock Configuration	124.00	10/300
201021	Zen Angle Holder 5x5 Advanced Interlock Configuration	122.00	10/250
201022	Zen Batten Holder 5x5 Advanced Interlock Configuration	122.00	10/250
207253	Ola Angle Holder Advanced Interlock Configuration	83.00	20/400
207254	Ola Batten Holder Advanced Interlock Configuration	83.00	20/400
207257	Uber Angle Holder Advanced Interlock Configuration	82.00	20/400
207258	Uber Batten Holder Advanced Interlock Configuration	82.00	20/400



Smart designs.  
Seamless power.

TRAVEL SMART.  
CHARGE  
SMARTER.  
VOLTUP



PLUG INTO  
SMARTER LIVING  
16A SMART  
WiFi POWER SOCKET

CHARGING  
MADE SIMPLE  
TERRA



STAY POWERED,  
ANYWHERE  
NOMA



SMART  
CHARGING,  
REDEFINED  
LINQ





Code	Item	MRP ₹	Pkg.
<b>HIGH GRADE POWER STRIP 240V~</b>			
205102	i-Design 4x1 Power Strip 4 Outlet International Socket With Master Switch & Indicator - 2 Mtr Cables	759.00	-/30
205238	i-Design 4x1 USB (A+A) Power Strip 3 Outlet International Socket, Dual USB Port (2A) - Output 2000mA. <b>NEW</b> With Master Switch & Indicator - 2 Mtr Cables	1025.00	-/30
205239*	i-Design 4x1 USB (A+C) Power Strip 3 Outlet International Socket, Dual USB Port (A+C) - Output 2000mA. <b>NEW</b> With Master Switch & Indicator - 2 Mtr Cables	1150.00	-/30
205240	i-Design 4x1 Power Strip 4 Outlet International Socket With Master Switch & Indicator - 5 Mtr Cables <b>NEW</b>	1250.00	-/30
205215	Zippo Power Strip with USB 3 Outlet International Socket, Master Switch, Indicator & 3 USB Ports - Output 2.1A Max - 1.5 Mtr Cables	1049.00	-/30



Code	Item	MRP ₹	Pkg.
<b>HIGH GRADE POWER STRIP 240V~</b>			
209051	Caterpillar 3+1 Power Strip 3 Outlet International Sockets With Safety Shutter, Master Switch With Indicator - 1.8 Mtr Cables	1000.00	-/30
209052	Caterpillar 3+1 Power Strip With USB Dual USB Port, 2 Outlet International Sockets With Safety Shutter, Master Switch With Indicator - 1.8 Mtr Cables	1200.00	-/30
209053	Turbomax 8+4 Power Strip 8 Outlet International Sockets With Safety Shutter, 3 USB + 1 USB C Type Ports, Master Switch With Indicator - 2 Mtr Cables	2888.00	-/30
209054	Turbocharge 4+3 Power Strip 4 Outlet International Sockets With Safety Shutter, Dual USB + 1 USB C Type Ports, Master Switch With Indicator - 2 Mtr Cables	1995.00	-/30
209055	TurboX 7+1 Power Strip <b>NEW</b> 4 Outlet International Sockets with Safety Shutter, 1 USB +2 TYPE C Ports, Total USB Output: 20W Master Switch With Indicator - 2 Mtr Cables	1785.00	-/30
209056	Turboplus+ 7+1 Power Strip <b>NEW</b> 4 Outlet International Sockets with Safety Shutter, 1 USB +2 TYPE C Ports, Total USB Output: 70W Master Switch With Indicator - 2 Mtr Cables	4200.00	-/30

\* introducing shortly



Code	Item	MRP ₹	Pkg.
<b>HIGH GRADE ADAPTORS SPIKE GUARD 240V~</b>			
205213	Logica 4x1 Spike Guard 4 Outlet International Sockets, Master Switch With Indicator & Reset Switch With Surge Protector - 2 Mtr Cables	738.00	-/30
205217	Spice Mini 4x1 <b>NEW</b> 4 Outlet International Sockets, Master Switch With Indicator & Reset Switch With Surge Protector - 2 Mtr Cables	663.00	-/30
205218	Spice Max 6x1 <b>NEW</b> 6 Outlet International Sockets, Master Switch With Indicator & Reset Switch With Surge Protector - 2 Mtr Cables	856.00	-/30
<b>2 PIN EXTENSION CORD</b>			
205122	Twister 2 Pin Master Switch With Indicator, International Socket & 2 Pin Sockets - 5 Mtr Cables	450.00	-/60
205128	G-Dial 2 Pin Master Switch With Indicator, International Socket & 2 Pin Sockets - 5 Mtr Cables	454.00	-/60
205133	Gio 2 Pin With Indicator & International Sockets - 2.5 Mtr Cables	387.00	-/60
205140	Infino 2 Pin Master Switch With Indicator, International Sockets & 2 Pin Socket - 5 Mtr Cables	540.00	-/60
205143*	Gyro 2 Pin <b>NEW</b> Master Switch With Indicator, International Socket & 2 Pin Sockets - 5 Mtr Cable	457.00	-/60



Code	Item	MRP ₹	Pkg.
<b>UNIVERSAL TRAVEL ADAPTOR 240V~ <b>NEW</b></b>			
202047	Genius USB Travel Adaptor Dual USB Port With 3 International Plug	1008.00	10/120
202048	Auro Travel Charger Input: 100-240V-50/60Hz 0.8A 36W Total Output Auto ID (118W Max) Output: 5V 3A 9V 2A 12V 1.5A USB+Type-C Output: 5V 3A - 2 Mtr Cables	2499.00	01/30
202050	Zesto Travel Adaptor Dual USB With International Socket	549.00	10/120



\* introducing shortly

Code	Item	MRP ₹	Pkg.
			Outer/Master
<b>UNIVERSAL TRAVEL ADAPTOR 240V-</b>			
209001	I-Charge - 17W CHARGER + NIGHT LAMP Dual USB Port With 3 International Plug Auto ID 1(18W Max) Output: 5V 3A 9V 2A 12V 1.5A USB+Type-C Output: 5V 3A Total Power: 18W (Max)	950.00	05/50
209002	I-Rapid - 25W CHARGER + NIGHT LAMP 1 USB A + 1 USB C Type Ports, PD Output: 5V 3A, 9V 2.78A, 12V 2.08A(25W) QC Output: 5V 3A, 9V 2A, A12V 1.5A (18W) Total Power: 25W (Max) 	1110.00	05/50
209003	I-Power - 30W CHARGER WITH DIGITAL DISPLAY 1 USB A + 1 USB C Type Ports, PD Output: 5V 3A, 9V 3A, 12V 2.5A, 15V 2A, 20V 1.5A (30W) PPS: 3.3-12V 2.5A, 3.3-20V 1.5A QC Output: 5V 4.5A, 9V 2A, 12V 2.5A (30W) Total Power: 30W (Max) 	1210.00	05/50
209004	16A Smart Wi-fi Power Socket For Air Conditioner & Geyser, Compatible With Amazon Alexa, Google Home	1950.00	05/100
209005	Nano Travel Adaptor With Mobile Stand, International Socket, 2 Pin Socket & Indicator	311.00	-/120
209006	Wall-E Travel Adaptor With Mobile Stand, 2 International Sockets, 2 Pin Sockets, Master Switch With Indicator	630.00	-/60
209007	Voltup Universal Travel Adaptor <b>NEW</b> International Sockets, 2 USB A Type + 2 USB C Type Ports, With Indicator	2900.00	-/120
209008	Bolt Universal Travel Adaptor <b>NEW</b> International Sockets, 2 USB A Type With Indicator	1050.00	-/120
209009	Bolt+ Universal Travel Adaptor <b>NEW</b> International Sockets, 2 USB A Type + 1 USB C Type Ports, With Indicator	1225.00	-/120
Please refer discount policy for Curve Plus Pro			



Offered in multiple color Combination

Code	Item	MRP ₹	Pkg.
			Outer/Master
<b>UNIVERSAL TRAVEL ADAPTOR 240V-</b>			
209012*	Terra - 45W Travel Adapter With Retractable Cable Input: 110-240 VAC 50/60Hz, 0.6A Output Cable : 25 Watt, Type-C: 20 Watt, USB-A: 20Watt, Type-C +USB-A : 5V-3A, Type-C Cable + Type-C: 45 Watt Type-C Cable + USB-A: 45 Watt Type-C Cable + Type-C+ USB-A : 40 Watt Total Output Power: 45W (Max)	-	-/120
209013*	Linq - 65W Travel Adapter With Retractable Cable Input: 110-240 VAC 50/60Hz, 1.5A USB-C1 Cable/C2 : 65 Watt USB-A: 20Watt USB-C1 Cable + USB-C2: 65Watt USB-C1 Cable + USB-A: 63 Watt USB-C2 + USB-A: 5V, 3.4A USB-C1 Cable + [USB-C2+USB-A]: 60 Watt Total Output Power: 65W (Max)	-	-/120
209014*	Tarq - 65W Travel Adaptor <b>NEW</b> Input: 110-240 VAC 50/60 Hz, 1.5A USB-C Output: 65 Watt PPS: 65 Watt USB-A Output: 30 Watt USB-C Output + USB-A Output: 45Watt + 10Watt Total Output Power: 65 Watt (Max)	-	-/120
209015*	Noma - 70W Travel Adaptor <b>NEW</b> Input: 110-240 VAC 50/60 Hz Universal Socket Output: 10A USB-C1: 70 Watt USB-C2: 5V, 3A USB-C3: 5V, 3A USB-A1: 24 Watt Cable: 70 Watt (70CM) Total Output Power: 70 Watt (Max)	-	-/120
209016*	Nord - 45W Travel Adaptor <b>NEW</b> Input: 110-240 VAC 50/60 Hz, 1.0A USB-C: 45 Watt PPS: 45 Watt USB-A: 30 Watt USB-C + USB-A: 5V, 5A Total Output Power: 45 Watt (Max)	-	-/120
<b>WIRELESS SPEAKER</b>			
209017*	Boom Wireless Speaker <b>NEW</b> With Light Wireless: V5.4 Input: DC5V,1A Rated Power: 5Watt Battery Capacity: 1200mAh	-	-/120
<b>POWER BANK</b>			
209018*	Zip Power Bank 10000mAh <b>NEW</b> Capacity: 10000mAh Type-C Input: 30Watt Type-C Cable Input: 30Watt Type-C Output: 35 Watt Type-C Cable Output: 35Watt Lightning Output: 20Watt Total Output : 5V, 3A	-	-/120
<b>MAGNETIC CABLE</b>			
209019*	Boost Magnetic Cable 100W <b>NEW</b> Compatible for Android Smartphone, Tablet, Power Bank, Bluetooth Speaker, Type-C Supported Devices	-	-/120



\* introducing shortly

With GOLDMEDAL,  
you are in safe hands!



Safeguards human life  
and property against  
the hazards of electrical  
mishaps.



Code	Item	Pole	MRP ₹	Pkg.
<b>ALLESSIO MINIATURE CIRCUIT BREAKER - 10ka C' CURVE - SP</b>				
02301	6A MCB	1	264.00	10/200
02302	10A MCB	1	264.00	10/200
02303	16A MCB	1	264.00	10/200
02304	20A MCB	1	264.00	10/200
02305	25A MCB	1	264.00	10/200
02306	32A MCB	1	264.00	10/200
02307	40A MCB	1	494.00	10/200
02308	63A MCB	1	578.00	10/200



Code	Item	Pole	MRP ₹	Pkg.
<b>ALLESSIO MINIATURE CIRCUIT BREAKER - 10ka C' CURVE - SPN</b>				
02311	6A MCB	2	714.00	6/120
02312	10A MCB	2	714.00	6/120
02313	16A MCB	2	714.00	6/120
02314	20A MCB	2	714.00	6/120
02315	25A MCB	2	714.00	6/120
02316	32A MCB	2	714.00	6/120
02317	40A MCB	2	1092.00	6/120
02318	63A MCB	2	1197.00	6/120



Code	Item	Pole	MRP ₹	Pkg.
<b>ALLESSIO MINIATURE CIRCUIT BREAKER - 10ka C' CURVE - DP</b>				
02320	6A MCB	2	788.00	6/120
02321	10A MCB	2	788.00	6/120
02322	16A MCB	2	788.00	6/120
02323	20A MCB	2	788.00	6/120
02324	25A MCB	2	788.00	6/120
02325	32A MCB	2	788.00	6/120
02326	40A MCB	2	1155.00	6/120
02327	63A MCB	2	1281.00	6/120



Code	Item	Pole	MRP ₹	Pkg.
<b>ALLESSIO MINIATURE CIRCUIT BREAKER - 10ka C' CURVE - TP</b>				
02330	6A MCB	3	1181.00	4/80
02331	10A MCB	3	1181.00	4/80
02332	16A MCB	3	1181.00	4/80
02333	20A MCB	3	1181.00	4/80
02334	25A MCB	3	1181.00	4/80
02335	32A MCB	3	1181.00	4/80
02336	40A MCB	3	1680.00	4/80
02337	63A MCB	3	1838.00	4/80



Code	Item	Pole	MRP ₹	Pkg.
<b>ALLESSIO MINIATURE CIRCUIT BREAKER - 10ka C' CURVE - TPN</b>				
02340	6A MCB	4	1470.00	3/60
02341	10A MCB	4	1470.00	3/60
02342	16A MCB	4	1470.00	3/60
02343	20A MCB	4	1470.00	3/60
02344	25A MCB	4	1470.00	3/60
02345	32A MCB	4	1470.00	3/60
02346	40A MCB	4	2090.00	3/60
02347	63A MCB	4	2184.00	3/60

Code	Item	Pole	MRP ₹	Pkg.
<b>ALLESSIO MINIATURE CIRCUIT BREAKER - 10ka C' CURVE - FP</b>				
02350	6A MCB	4	1670.00	3/60
02351	10A MCB	4	1670.00	3/60
02352	16A MCB	4	1670.00	3/60
02353	20A MCB	4	1670.00	3/60
02354	25A MCB	4	1670.00	3/60
02355	32A MCB	4	1670.00	3/60
02356	40A MCB	4	2258.00	3/60
02357	63A MCB	4	2363.00	3/60



Code	Item	Pole	MRP ₹	Pkg.
<b>ALLESSIO MINIATURE CIRCUIT BREAKER - 10ka B' CURVE - SP</b>				
02501	6A MCB	1	262.00	10/200
02502	10A MCB	1	262.00	10/200
02503	16A MCB	1	262.00	10/200
02504	20A MCB	1	262.00	10/200
02505	25A MCB	1	262.00	10/200
02506	32A MCB	1	262.00	10/200
02507	40A MCB	1	513.00	10/200
02508	63A MCB	1	600.00	10/200



Code	Item	Pole	MRP ₹	Pkg.
<b>ALLESSIO ISOLATOR - DP</b>				
02360	40A Isolator	2	515.00	6/120
02361	63A Isolator	2	704.00	6/120
02362	100A Isolator	2	893.00	6/120



Code	Item	Pole	MRP ₹	Pkg.
<b>ALLESSIO ISOLATOR - TP</b>				
02368	40A Isolator	3	798.00	4/80
02369	63A Isolator	3	998.00	4/80
02370	100A Isolator	3	1302.00	4/80



Code	Item	Pole	MRP ₹	Pkg.
<b>ALLESSIO ISOLATOR - FP</b>				
02376	40A Isolator	4	1103.00	3/60
02377	63A Isolator	4	1365.00	3/60
02378	100A Isolator	4	1680.00	3/60



Code	Item	Pole	MRP ₹	Pkg.
<b>ALLESSIO CHANGEOVER - DP</b>				
02381	25A Changeover	2	998.00	6/120
02382	32A Changeover	2	1208.00	6/120
02383	40A Changeover	2	1449.00	6/120
02384	63A Changeover	2	1838.00	6/120



Code	Item	Pole	MRP ₹	Pkg.
<b>ALLESSIO CHANGEOVER - FP</b>				
02386	25A Changeover	4	2111.00	3/60
02387	32A Changeover	4	2415.00	3/60
02388	40A Changeover	4	2940.00	3/60
02389	63A Changeover	4	3465.00	3/60





IS/REC-12640-1



IS/REC-12640-1



Code	Item	Pole	MRP ₹	Pkg.	Outer/ Master

**ALLESSIO RCCB - 10kA - DP**

02400	25A RCCB 30mA	2	2426.00	6/120	
02401	25A RCCB 100mA	2	2457.00	6/120	
02402	25A RCCB 300mA	2	2478.00	6/120	
02403	40A RCCB 30mA	2	2636.00	6/120	
02404	40A RCCB 100mA	2	2688.00	6/120	
02405	40A RCCB 300mA	2	2720.00	6/120	
02406	63A RCCB 30mA	2	3329.00	6/120	
02407	63A RCCB 100mA	2	3392.00	6/120	
02408	63A RCCB 300mA	2	3455.00	6/120	

**ALLESSIO RCCB - 10kA - FP** Module

02412	25A RCCB 30mA	4	2993.00	3/60	
02413	25A RCCB 100mA	4	3150.00	3/60	
02414	25A RCCB 300mA	4	3266.00	3/60	
02415	40A RCCB 30mA	4	3150.00	3/60	
02416	40A RCCB 100mA	4	3201.00	3/60	
02417	40A RCCB 300mA	4	3329.00	3/60	
02418	63A RCCB 30mA	4	3570.00	3/60	
02419	63A RCCB 100mA	4	3696.00	3/60	
02420	63A RCCB 300mA	4	3812.00	3/60	

**ALLESSIO 32A DP MCB WITH ENCLOSURE**

02426	32A DP MCB with Enclosure		473.00	5/100	
-------	---------------------------	--	--------	-------	--

**AUTOMATIC CHANGEOVER WITH CURRENT LIMITER (ACCL) - SPN** NEW

02451	Mains 32A, Genset 1.5A - 300W		2519.00	3/60	
02452	Mains 32A, Genset 2.5A - 500W		2519.00	3/60	
02453	Mains 32A, Genset 3A - 600W		2519.00	3/60	
02454	Mains 32A, Genset 4A - 800W		2519.00	3/60	
02455	Mains 32A, Genset 5A - 1000W		2519.00	3/60	
02456	Mains 32A, Genset 6A - 1200W		2519.00	3/60	
02457	Mains 32A, Genset 9A - 1800W		2519.00	3/60	
02458	Mains 32A, Genset 12A - 2400W		2519.00	3/60	
02459	Mains 32A, Genset 15A - 3000W		2519.00	3/60	
02460	Mains 32A, Genset 20A - 4000W		2519.00	3/60	
02461	Mains 32A, Genset 30A - 6000W		2519.00	3/60	

**AUTOMATIC CHANGEOVER WITH CURRENT LIMITER (ACCL) - SPN WITH DISPLAY** NEW

02462	Mains 32A, Genset 32A - 6000W On site programmable DG Current limit 0-32A <b>(With extra safety features)</b>		3674.00	3/60	
-------	--	--	---------	------	--

Code	Item	No of Modules			MRP ₹	Pkg.	Outer/ Master
		Incomer	Sub Incomer	Outgoing			

**AUTOMATIC CHANGEOVER WITH CURRENT LIMITER (ACCL) - TPN WITH DISPLAY** NEW

02463	Mains 40A, Genset 40A - 8000W				11549.00	1/4	
02464	Mains 63A, Genset 63A - 12000W On site programmable DG Current limit 0-40/63A <b>(With extra safety features)</b>				20948.00	1/4	

**ALLESSIO ROTARY SWITCH**

02433	3 Way - 40A				961.00	1/40	
02434	3 Way - 63A				1125.00	1/40	

**ALLESSIO DOUBLE DOOR DB's - PLASTIC WITH METAL BASE**

04152	4 - 6 Way	2	-	4	1504.00	1/10	
04153	7 - 9 Way	2	-	7	1791.00	1/10	
04154	10 - 12 Way	2	-	10	2121.00	1/10	
04155	13 - 16 Way	2	-	14	2523.00	1/5	
04156	16 - 20 Way	2	-	18	2946.00	1/5	

Fireproof Plastic with transparent cover

**ALLESSIO SINGLE DOOR (METAL) DISTRIBUTION BOARD - IP30 - SPN**

04191	4 Way	2	-	2	1219.00	1/12	
04192	8 Way	2	-	6	1525.00	1/9	
04193	12 Way	2	-	10	1808.00	1/9	
04194	16 Way	2	-	14	2252.00	1/6	

•Conforms to IS 8623-1 & 3, IEC 61439-1 & 3 •IP-30.  
 •Suitable for Surface & Flush mounting. •Enclosure is made up of CRCA Sheet steel, RAL 9003 Powder coated, •with din rail, removable bus -bar, shrouded neutral/earth link with Conditional Short Circuit Rating of 15kA in SPN DB provided with isolable neutral link to carry out isolation test, also with high integrity/Clean Earth kit as accessory for electronic/IT installation to meet international safety standard DBs design with ample space for wiring. •There is a provision for DP MCB /Isolator/ RCCB/RCBO as incomer & SP MCBs as outgoing.



Safe, reliable  
and efficient.

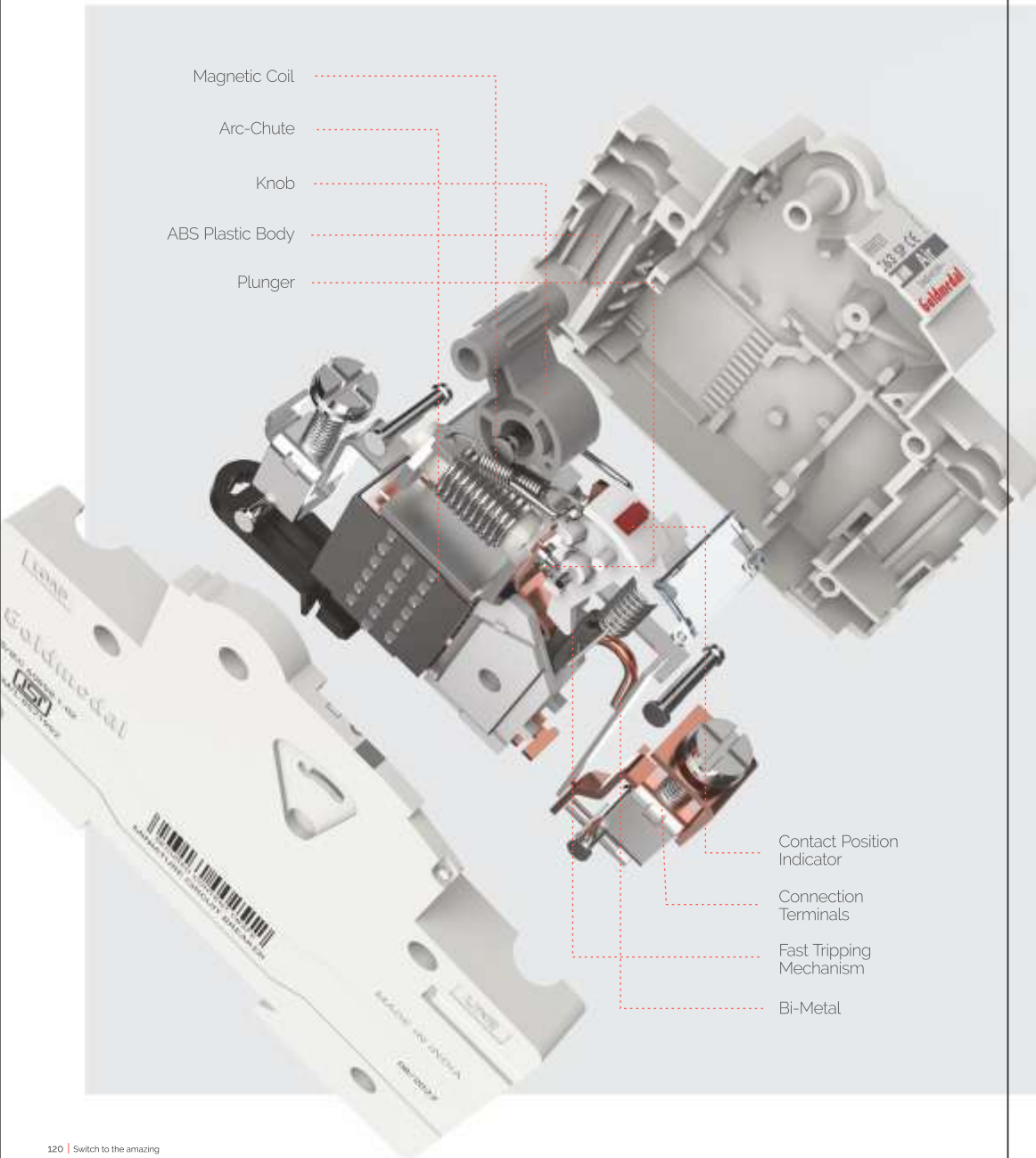

## AirMCB

Compared to a traditional fuse, MCBs are designed to operate accurately under both overloading and short circuit conditions. Unlike a fuse, MCBs can also be reset quickly after they trips. RCCBs play an equally important role by automatically detecting and disconnecting the circuit whenever a fault occurs or the current exceeds the rated sensitivity. The MCBs and RCCBs from Goldmedal are housed within a plastic moulding that is made of flame-retardant, high strength plastic. The quality of the material used and its design ensures that these devices are highly durable and appear new in spite of years of use.

Maximum safety,  
seamless power control.



**Air RCCB | CHANGEOVER**

Rapidly cuts off power during abnormal currents, preventing electric shock and enhancing home safety.

Code	Item	Pole	MRP ₹	Pkg.
<b>NEW</b>				
<b>AIR MINIATURE CIRCUIT BREAKER - 10kA B' CURVE - SP</b>				
07301	6A MCB	1	249.00	10/200
07302	10A MCB	1	249.00	10/200
07303	16A MCB	1	249.00	10/200
07304	20A MCB	1	249.00	10/200
07305	25A MCB	1	249.00	10/200
07306	32A MCB	1	249.00	10/200
07307	40A MCB	1	286.00	10/200
07308	63A MCB	1	334.00	10/200
<b>NEW</b>				
<b>AIR MINIATURE CIRCUIT BREAKER - 10kA C' CURVE - SP</b>				
07360	6A MCB	1	251.00	10/200
07361	10A MCB	1	251.00	10/200
07362	16A MCB	1	251.00	10/200
07363	20A MCB	1	251.00	10/200
07364	25A MCB	1	251.00	10/200
07365	32A MCB	1	251.00	10/200
07366	40A MCB	1	473.00	10/200
07367	63A MCB	1	546.00	10/200
<b>NEW</b>				
<b>AIR MINIATURE CIRCUIT BREAKER - 10kA C' CURVE - SPN</b>				
07370	6A MCB	2	683.00	6/120
07371	10A MCB	2	683.00	6/120
07372	16A MCB	2	683.00	6/120
07373	20A MCB	2	683.00	6/120
07374	25A MCB	2	683.00	6/120
07375	32A MCB	2	683.00	6/120
07376	40A MCB	2	1040.00	6/120
07377	63A MCB	2	1103.00	6/120
<b>NEW</b>				
<b>AIR MINIATURE CIRCUIT BREAKER - 10kA C' CURVE - DP</b>				
07380	6A MCB	2	748.00	6/120
07381	10A MCB	2	748.00	6/120
07382	16A MCB	2	748.00	6/120
07383	20A MCB	2	748.00	6/120
07384	25A MCB	2	748.00	6/120
07385	32A MCB	2	748.00	6/120
07386	40A MCB	2	1103.00	6/120
07387	63A MCB	2	1197.00	6/120





Code	Item	Pole	MRP ₹	Pkg. Outer/Master
<b>AIR MINIATURE CIRCUIT BREAKER - 10kA C' CURVE - TP</b> <span style="float: right;">NEW</span>				
07390	6A MCB	3	1121.00	4/80
07391	10A MCB	3	1121.00	4/80
07392	16A MCB	3	1121.00	4/80
07393	20A MCB	3	1121.00	4/80
07394	25A MCB	3	1121.00	4/80
07395	32A MCB	3	1121.00	4/80
07396	40A MCB	3	1575.00	4/80
07397	63A MCB	3	1733.00	4/80



Code	Item	Pole	MRP ₹	Pkg. Outer/Master
<b>AIR MINIATURE CIRCUIT BREAKER - 10kA C' CURVE - TPN</b> <span style="float: right;">NEW</span>				
07400	6A MCB	4	1436.00	3/60
07401	10A MCB	4	1436.00	3/60
07402	16A MCB	4	1436.00	3/60
07403	20A MCB	4	1436.00	3/60
07404	25A MCB	4	1436.00	3/60
07405	32A MCB	4	1436.00	3/60
07406	40A MCB	4	1985.00	3/60
07407	63A MCB	4	2079.00	3/60



Code	Item	Pole	MRP ₹	Pkg. Outer/Master
<b>AIR MINIATURE CIRCUIT BREAKER - 10kA C' CURVE - FP</b> <span style="float: right;">NEW</span>				
07410	6A MCB	4	1586.00	3/60
07411	10A MCB	4	1586.00	3/60
07412	16A MCB	4	1586.00	3/60
07413	20A MCB	4	1586.00	3/60
07414	25A MCB	4	1586.00	3/60
07415	32A MCB	4	1586.00	3/60
07416	40A MCB	4	2195.00	3/60
07417	63A MCB	4	2300.00	3/60



Code	Item	Pole	MRP ₹	Pkg. Outer/Master
<b>AIR ISOLATOR - DP</b> <span style="float: right;">NEW</span>				
07420	40A Isolator	2	509.00	6/120
07421	63A Isolator	2	651.00	6/120
07422	100A Isolator	2	835.00	6/120



Code	Item	Pole	MRP ₹	Pkg. Outer/Master
<b>AIR ISOLATOR - TP</b> <span style="float: right;">NEW</span>				
07428	40A Isolator	3	746.00	4/80
07429	63A Isolator	3	919.00	4/80
07430	100A Isolator	3	1239.00	4/80

Code	Item	Pole	MRP ₹	Pkg. Outer/Master
<b>AIR ISOLATOR - FP</b> <span style="float: right;">NEW</span>				
07436	40A Isolator	4	1024.00	3/60
07437	63A Isolator	4	1187.00	3/60
07438	100A Isolator	4	1512.00	3/60



Code	Item	Pole	MRP ₹	Pkg. Outer/Master
<b>AIR CHANGEOVER - DP</b> <span style="float: right;">NEW</span>				
07446	25A Changeover	2	914.00	6/120
07447	32A Changeover	2	1155.00	6/120
07448	40A Changeover	2	1386.00	6/120
07449	63A Changeover	2	1764.00	6/120



Code	Item	Pole	MRP ₹	Pkg. Outer/Master
<b>AIR CHANGEOVER - FP</b> <span style="float: right;">NEW</span>				
07451	25A Changeover	4	1859.00	3/60
07452	32A Changeover	4	2294.00	3/60
07453	40A Changeover	4	2809.00	3/60
07454	63A Changeover	4	3392.00	3/60



Code	Item	Pole	MRP ₹	Pkg. Outer/Master
<b>AIR RCCB - 10kA - DP</b> <span style="float: right;">NEW</span>				
07460	25A RCCB 30mA	2	2373.00	6/120
07461	25A RCCB 100mA	2	2405.00	6/120
07462	25A RCCB 300mA	2	2426.00	6/120
07463	40A RCCB 30mA	2	2583.00	6/120
07464	40A RCCB 100mA	2	2636.00	6/120
07465	40A RCCB 300mA	2	2667.00	6/120
07466	63A RCCB 30mA	2	3276.00	6/120
07467	63A RCCB 100mA	2	3339.00	6/120
07468	63A RCCB 300mA	2	3402.00	6/120



Code	Item	Module	MRP ₹	Pkg. Outer/Master
<b>AIR RCCB - 10kA - FP</b> <span style="float: right;">NEW</span>				
07472	25A RCCB 30mA	4	2940.00	3/60
07473	25A RCCB 100mA	4	3098.00	3/60
07474	25A RCCB 300mA	4	3213.00	3/60
07475	40A RCCB 30mA	4	3098.00	3/60
07476	40A RCCB 100mA	4	3149.00	3/60
07477	40A RCCB 300mA	4	3276.00	3/60
07478	63A RCCB 30mA	4	3518.00	3/60
07479	63A RCCB 100mA	4	3644.00	3/60
07480	63A RCCB 300mA	4	3759.00	3/60



Code	Item	MRP ₹	Pkg. Outer/Master
<b>AIR 32A DP MCB WITH ENCLOSURE</b> <span style="float: right;">NEW</span>			
07491	32A DP Enclosure	420.00	5/100



Premium performance.  
Ultimate protection.



AERO



Aero Double Door Plastic (DB)  
with Transparent Door Flap



Technical Features

- Conforms to IS 8623-1&3, IEC 61439-1&3 standards
- Suitable for Surface & flush mounting
- Dust proof IP40 & IK07 compliant
- Manufactured using Main Body & Door - Heavy Duty Plastic Material
- Ample space provided for proper placement of neutral & earth wires.



Code	Item	No of Modules			MRP ₹	Pkg.
		Outer/Master				
		Incomer	Sub Incomer	Outgoing		

**AIR SINGLE DOOR (METAL) DB - IP30 - SPN**

07001	4 Way	2	-	2	985.00	1/16
07002	6 Way	2	-	4	1207.00	1/16
07003	8 Way	2	-	6	1252.00	1/12
07004	12 Way	2	-	10	1637.00	1/12
07005	16 Way	2	-	14	1894.00	1/9
07006	18 Way	2	-	16	2182.00	1/9

**AIR SINGLE DOOR (METAL) DB - IP30 - TPN**

07011	4 Way	4	-	4+4+4	2581.00	1/6
07012	6 Way	4	-	6+6+6	3356.00	1/6
07013	4 Way	8	-	4+4+4	2857.00	1/6
07014	6 Way	8	-	6+6+6	3236.00	1/6
07015	8 Way	8	-	8+8+8	3862.00	1/6
07016	12 Way	8	-	12+12+12	6146.00	1/3
07017	16 Way	8	-	16+16+16	7359.00	1/3

• Confirms to IS 8623-1 & 3, IEC 61439-1 & 3 • IP-30 for Single Door. • Suitable for Surface & Flush mounting. • Enclosure is made up of CRCA Sheet steel, RAL 9003 Powder coated, • Ready to use DBs - includes 100A insulated Phase Bus-bar, Shrouded Neutral /Earth bar with Conditional short circuit Rating. This DB's kit includes high integrity accessories like Cement spill protector sheet, Colour-coded inter connecting wire set, Cable ties, Blank Module, Sticking saddles, Circuit identification labels. • There is a provision for- 1) SPN: DP MCB /Isolator/ RCCB/RBDO as incomer & SP MCBs as outgoing. 2) TPN: FP MCB /Isolator/ RCCB/RBDO as incomer & SP/TP MCBs as outgoing.

**AIR SINGLE DOOR (METAL) 63A TPN PHASE SELECTOR DB - IP-30**

07021	4 Way	8	-	4+4+4	9245.00	1/1
07022	6 Way	8	-	6+6+6	10075.00	1/1
07023	8 Way	8	-	8+8+8	10620.00	1/1
07024	12 Way	8	-	12+12+12	11756.00	1/1

• Confirms to IS 8623-1 & 3, IEC 61439-1 & 3 • IP-30 for single door. • Suitable for Surface & flush mounting. • Enclosure is made up of CRCA Sheet steel, RAL 9003 Powder coated, • DB has two separate compartments for MCB & Phase selector Switches, which includes 3 Nos. of 63A rotary switches, 3 Nos. of Rocker Switches for Phase identification, 100A insulated Phase Bus-bar, Shrouded Neutral /Earth bar with Conditional Short Circuit Rating. This DB's kit includes high integrity accessories like Cement spill protector sheet, Colour-coded inter connecting wire set, Cable ties, Blank Module, Sticking saddles, Circuit identification labels. • There is a provision for FP MCB /Isolator/RCCB/RBDO as incomer & SP/TP MCBs as outgoing

**AIR SINGLE DOOR (METAL) 63A TPN PHASE SELECTOR ENCLOSURE DB - IP-30**

07025	Phase Selector Enclosure with 1 Rotary Switch	-	-	-	2266.00	1/10
07026	Phase Selector Enclosure with 3 Rotary Switch	-	-	-	7240.00	1/4

• Confirms to IS 8623-1 & 3, IEC 61439-1 & 3 • IP-30 for single door. • Suitable for Surface & flush mounting. • Available in CRCA Sheet steel, RAL9003 powder coated, • Ready to use DBs Phase selector Enclosure which includes 3 Nos. & 1 Nos. of 63A rotary Switches, 3 Nos. of Indicator for phase identification.

**AIR AC (METAL) PLUG & SOC. DB**

Code	Item	No. of Pins	Modules	MRP ₹	Pkg.	
						07032
07033	20A 2 Pin	-	P+N	2	783.00	1/24
07034	20A 3 Pin	-	3P	4	1590.00	1/16
07035	32A 3 Pin	-	3P	4	2264.00	1/8
07036	63A 5 Pin	-	3P+N+E	4	10453.00	1/6

• Confirms to IS 8623-1 & 3, IEC 61439-1 & 3 • Suitable for Surface & Flush mounting. • Enclosure is made up of CRCA sheet steel, RAL 9003 powder coated. • Loose Metal & Plastic Plugs & Sockets confirms to IS 8804 in single phase & three phase.

**AIR AC (PLASTIC) PLUG & SOC. DB**

Code	Item	No. of Pins	Modules	MRP ₹	Pkg.	
						07041
07042	32A 3 Pin	-	P+N+E	4	3317.00	1/16
07043	32A 5 Pin	-	3P+N+E	8	3911.00	1/10
07044	63A 5 Pin	-	3P+N+E	8	10886.00	1/8

• Confirms to IS 8623-1 & 3, IEC 61439-1 & 3 • Reversible double door for IP-43 & IK-09 Dbs. • Suitable for Surface & Flush Mounting. • Enclosure is made up of CRCA Sheet steel, RAL 9003 Powder coated, • Ready to use DBs - includes 100A insulated Phase Bus-bar, Shrouded Neutral / Earth bars with conditional Short Circuit Rating. This DB's kit includes high integrity accessories like Cement spill protector sheet, Colour-coded inter connecting wire set, Cable ties, Blank Module, Sticking Saddles, Circuit identification labels. • There is a provision for FP MCB /Isolator/RCCB/RBDO as incomer & DPRCCB/ RBDO as sub-comer, SP MCBs as outgoing. \*suitable for 3P/4P MCCB as incomer

Code	Item	No of Modules			MRP ₹	Pkg.
		Outer/Master				
		Incomer	Sub Incomer	Outgoing		

**AIR AC (PLASTIC) PLUG & SOCKET DB (WITH PLASTIC COVER)**

07045	20A 2 Pin	-	P+N	1	679.00	1/24
07046	20A 2 Pin	-	P+N	2	679.00	1/24

• Confirms to IS 8623-1 & 3, IEC 61439-1 & 3 • Suitable for Surface & Flush mounting. • Enclosure is made up of CRCA sheet steel, RAL 9003 powder coated. • Loose Metal & Plastic Plugs & Sockets confirms to IS 8804 in single phase & three phase.

**AIR (METAL) ENCLOSURE IP-30**

07051	2 Way	-	2	-	372.00	1/24
07052	4 Way	-	4	-	481.00	1/24
07053	6 Way	-	6	-	601.00	1/24
07054	8 Way	-	8	-	731.00	1/24

• Confirms to IS 8623-1 & 3, IEC 61439-1 & 3 • Suitable for Surface & Flush mounting. • Enclosure is made up of CRCA sheet steel, RAL 9003 powder coated. • There is a provision to mount MCB as Isolator, RCCB/RBDO & other modular devices.

**AIR DOUBLE DOOR (METAL) DB - IP43 - SPN**

07056	4 Way	2	-	2	1542.00	1/12
07057	6 Way	2	-	4	1804.00	1/12
07058	8 Way	2	-	6	1985.00	1/8
07059	12 Way	2	-	10	2489.00	1/8
07060	16 Way	2	-	14	3075.00	1/6
07061	18 Way	2	-	16	3585.00	1/6

**AIR DOUBLE DOOR (METAL) DB - IP43 - TPN**

07066	4 Way	4	-	4+4+4	3884.00	1/4
07067	6 Way	4	-	6+6+6	4829.00	1/4
07068	4 Way	8	-	4+4+4	4409.00	1/4
07069	6 Way	8	-	6+6+6	4415.00	1/4
07070	8 Way	8	-	8+8+8	5487.00	1/4
07071	12 Way	8	-	12+12+12	7789.00	1/1
07072	16 Way	8	-	16+16+16	9396.00	1/1

• Confirms to IS 8623-1 & 3, IEC 61439-1 & 3 • Reversible Door for IP-43 & IK-09 Dbs. • Suitable for Surface & Flush mounting. • Enclosure is made up of CRCA Sheet steel, RAL 9003 Powder coated, • Ready to use DBs - includes 100A insulated Phase Bus-bar, Shrouded Neutral /Earth bar with Conditional short circuit Rating. This DB's kit includes high integrity accessories like Cement spill protector sheet, Colour-coded inter connecting wire set, Cable ties, Blank Module, Sticking saddles, Circuit identification labels. • There is a provision for- 1) SPN: DP MCB /Isolator/ RCCB/RBDO as incomer & SP MCBs as outgoing. 2) TPN: FP MCB /Isolator/ RCCB/RBDO as incomer & SP/TP MCBs as outgoing.

**AIR DOUBLE DOOR (METAL) DB - IP43- TPN HORIZONTAL PPI**

07076	4+2 Way	8	2+2+2	4+4+4	6767.00	1/4
07077	6+2 Way	8	2+2+2	6+6+6	8306.00	1/4
07078	8+2 Way	8	2+2+2	8+8+8	9833.00	1/4
07079	12+2 Way	8	2+2+2	12+12+12	10816.00	1/1
07080	16+2 Way	8	2+2+2	16+16+16	11897.00	1/1

**AIR DD (METAL) DB - IP43- TPN TIER PPI**

07086	4+2 Way	8	2+2+2	4+4+4	6017.00	1/1
07087	6+2 Way	8	2+2+2	6+6+6	8018.00	1/1
07088	8+2 Way	8	2+2+2	8+8+8	9923.00	1/1
07089	10+2 Way	8	2+2+2	10+10+10	11411.00	1/1
07090	12+2 Way	8	2+2+2	12+12+12	11649.00	1/1
07091	16+2 Way	8	2+2+2	16+16+16	12404.00	1/1

• Confirms to IS 8623-1 & 3, IEC 61439-1 & 3 • Reversible double door for IP-43 & IK-09 Dbs. • Suitable for Surface & Flush Mounting. • Enclosure is made up of CRCA Sheet steel, RAL 9003 Powder coated, • Ready to use DBs - includes 100A insulated Phase Bus-bar, Shrouded Neutral / Earth bars with conditional Short Circuit Rating. This DB's kit includes high integrity accessories like Cement spill protector sheet, Colour-coded inter connecting wire set, Cable ties, Blank Module, Sticking Saddles, Circuit identification labels. • There is a provision for FP MCB /Isolator/RCCB/RBDO as incomer & DPRCCB/ RBDO as sub-comer, SP MCBs as outgoing. \*suitable for 3P/4P MCCB as incomer





Code	Item	No of Modules			MRP ₹	Pkg.	Outer/ Master
		Incomer	Sub Incomer	Outgoing			

**AIR DD (METAL) DB - IP43- TPN PHASE SEGREGATED- 7 SEGMENT**

07096	4 Way	8	4+4+4	4+4+4	9932.00	1/1
07097	6 Way	8	4+4+4	6+6+6	11224.00	1/1
07098	8 Way	8	4+4+4	8+8+8	12898.00	1/1
07099	12 Way	8	4+4+4	12+12+12	16127.00	1/1

•Conforms to IS 8623-1 & 3, IEC 61439-1 & 3 IP-43 & IK-09 for double door.  
 •Suitable for Surface & Flush mounting. •Separate compartment for Incomer, Sub-incomer & Outgoing device. •Enclosure is made up of CRCA Sheet steel, RAL 9003 Powder coated. •Ready to use DBs- includes 100A insulated Phase Bus-bar, Shrouded Neutral / Earth bar with Conditional Short Circuit Rating. This DB's kit includes high integrity accessories like Cement spill protector sheet, Colour-coded inter connecting wire set, Cable ties, Blank module, Sticking Saddles, Circuit identification labels.  
 •There is a provision for-  
 1) Modular Incomer - FP MCB/Isolator as incomer, DP RCCB/RCBO as sub-incomer & SP MCBs as outgoing.  
 2) MCCB Incomer -TP/FP MCCB as incomer, DP RCCB/RCBO as Sub-incomer & SP MCBs as outgoing.

**AIR DD (METAL) DB - IP43- VERTICAL TPN MCB IC**

07106	4 Way	8	-	4+4+4	10065.00	1/1
07107	6 Way	8	-	6+6+6	12056.00	1/1
07108	8 Way	8	-	8+8+8	12658.00	1/1
07109	12 Way	8	-	12+12+12	15907.00	1/1
07110	16 Way	8	-	16+16+16	19845.00	1/1

•Conforms to IS 8623-1 & 3, IEC 61439-1 & 3 •Reversible Door for IP-43 & IK -09 Dbs.  
 •Suitable for Surface & Flush mounting. •Enclosure is made up of CRCA Sheet steel, RAL 9003 Powder coated. •Ready to use DB includes insulated Vertical Phase Bus-bar, Shrouded Neutral / Earth bar with Conditional Short Circuit Rating. This DB's kit includes high integrity accessories like Cement spill protector sheet, Colour-coded inter connecting wire set, Cable ties, Blank Module, Sticking Saddles, Circuit identification labels. •There is a provision for-  
 1)MCB IC : FP MCB/Isolator/RCCB/RCBO as incomer & SP/TP MCBs as outgoing.  
 2)MCCC IC: MCCB as incomer & SP/TP MCBs as outgoing.  
 \*Suitable for 3 pole / 4 pole MCCB as incomer.

**AIR DD (METAL) DB - IP43- FLEXI ROW** Modules Per Row

07126	2 Row	-	-	14	5430.00	1/1
07127	3 Row	-	-	14	6457.00	1/1
07128	4 Row	-	-	14	7176.00	1/1
07129	4 Row	-	-	16	7832.00	1/1

•Conforms to IS 8623-1 & 3, IEC 61439-1 & 3 •Reversible Door for IP-43 & IK -09 Dbs.  
 •Suitable for Surface & Flush mounting. •Enclosure is made up of CRCA Sheet steel, RAL 9003 Powder coated. •Ready to use DB includes Shrouded Neutral /Earth bar with Conditional Short Circuit Rating. Bus bar to be selected as per distribution requirements. This DB's kit includes high integrity accessories like Cement spill protector sheet, Cable ties, Blank Module, Sticking Saddles, Circuit identification labels. •There is a provision to mount modular devices as per requirement.

**AIR DD (METAL) DB IP-43 TPN 63A PHASE SELECTOR**

07131	4 Way	8	-	4+4+4	12912.00	1/1
07132	6 Way	8	-	6+6+6	13474.00	1/1
07133	8 Way	8	-	8+8+8	14627.00	1/1
07134	12 Way	8	-	12+12+12	16480.00	1/1

•Conforms to IS 8623-1 & 3, IEC 61439-1 & 3 •Reversible Door for IP-43 & IK -09 Dbs .  
 •Suitable for Surface & flush mounting. •Enclosure is made up of CRCA Sheet steel, RAL 9003 Powder coated. •DB has two separate compartments for MCB & Phase selector Switches, which includes 3 Nos. of 63A rotary switches, 3 Nos. of Rocker Switches for Phase identification, 100A insulated Phase Bus-bar, Shrouded Neutral /Earth bar with Conditional Short Circuit Rating. This DB's kit includes high integrity accessories like Cement spill protector sheet, Colour-coded inter connecting wire set, Cable ties, Blank Module, Sticking saddles, Circuit identification labels. •There is a provision for FP MCB /Isolator/RCCB/RCBO as incomer & SP/TP MCBs as outgoing.



Code	Item	No of Modules			MRP ₹	Pkg.	Outer/ Master
		Incomer	Sub Incomer	Outgoing			

**AIR DD (METAL) DB IP-43 TV/TEL. SPN WITH TV SPLITTER & TEL. CRONE MODULE**

07141	4 Way	2	-	2	2830.00	1/6
07142	6 Way	2	-	4	3334.00	1/6
07143	8 Way	2	-	6	4338.00	1/4
07144	12 Way	2	-	10	4894.00	1/4
07145	16 Way	2	-	14	5712.00	1/4

**AIR DD (METAL) DB IP-43 TV/TEL. TPN WITH TV SPLITTER & TEL. CRONE MODULE**

07151	4 Way	8	-	4+4+4	6937.00	1/3
07152	6 Way	8	-	6+6+6	7371.00	1/3
07153	8 Way	8	-	8+8+8	8171.00	1/3
07154	12 Way	8	-	12+12+12	8939.00	1/3

•Conforms to IS 8623-1 & 3, IEC 61439-1 & 3 •Reversible Door for IP-43 & IK -09 Dbs .  
 •Suitable for Surface & Flush Mounting. •Enclosure is made up of CRCA Sheet steel, RAL 9003 Powder coated. •Ready to use DBs- includes 100A insulated Phase Bus-bar, Shrouded Neutral /Earth bar with Conditional Short Circuit Rating & having telephone socket & TV co-axial socket. This DB's kit includes high integrity accessories like Cement spill protector sheet, Colour-coded inter connecting wire set, Cable ties, Blank Module, Sticking Saddles, Circuit identification labels. •There is a provision for-  
 1)SPN DP MCB /Isolator/ RCCB/RCBO as incomer & SP MCBs as outgoing.  
 2)TPN:FP MCB /Isolator/ RCCB/RCBO as incomer & SP/TP MCBs as outgoing.

**AIR DBS ACCESSORIES** No. of Pins    Modules

07037	20A 2 Pin Soc.	-	P + N	-	211.00	10/100
07038	20A 2 Pin Plug	-	P + N	-	216.00	10/100
07201	Blanking Plate	-	-	1	16.00	50/500



**AIR DD (METAL) DB IP-43 BUS BAR CHAMBER**

07171	32A/415V	-	-	4	2751.00	1/5
07172	63A/415V	-	-	4	4483.00	1/5
07173	100A/415V	-	-	4	5600.00	1/3
07174	200A/415V	-	-	4	9857.00	1/2
07175	320A/415V	-	-	4	15032.00	1/1
07176	400A/415V	-	-	4	20873.00	1/1
07177	630A/415V	-	-	4	36929.00	1/1



**AIR DOUBLE DOOR DB's - PLASTIC WITH METAL BASE**

07186	4 - 6 Way	2	-	4	1484.00	1/10
07187	6 - 8 Way	2	-	6	1767.00	1/10
07188	10 - 12 Way	2	-	10	2093.00	1/10
07189	12 - 16 Way	2	-	14	2490.00	1/5
07190	16 - 20 Way	2	-	18	2907.00	1/5



**AERO DOUBLE DOOR DB's - PLASTIC BASE** **NEW**

07193	4 - 6 Way	2	-	4	1709.00	1/10
07194	6 - 8 Way	2	-	6	2036.00	1/10
07195	10 - 12 Way	2	-	10	2407.00	1/10
07196	12 - 16 Way	2	-	14	2865.00	1/5
07197	16 - 20 Way	2	-	18	3346.00	1/5

Fireproof Plastic with transparent cover



# Solving your electrical challenges, precisely.



## AirecoDB

The AirEcoDB distribution boards are sleek, stylish and elegant in appearance. Its appearance reflects the supremely minimalistic look of the AIR Range to which it belongs. Its crisp, clean lines accentuate the powder-coated, superior finish and durability of the product. Suitable for flush and wall mounting, the AIR DBs offer ample space for easy installation of MCBs, RCCBs and for all the wiring required. The AIR Distribution Board also complies with all the standard requirements and is water and weather resistant so that it retains its international look even after years of use.

Code	Item	No of Modules			MRP ₹	Pkg. Outer/ Master
		Incomer	Sub Incomer	Outgoing		

### AIR ECO DOUBLE DOOR (METAL) DB - IP42 - SPN

07211	4 Way	2	-	2	1352.00	1/12
07212	6 Way	2	-	4	1537.00	1/12
07213	8 Way	2	-	6	1865.00	1/8
07214	10 Way	2	-	8	2111.00	1/8
07215	12 Way	2	-	10	2438.00	1/8
07216	16 Way	2	-	14	2888.00	1/6

### AIR ECO DOUBLE DOOR (METAL) DB - IP42 - TPN

07221	4 Way	6	-	4+4+4	3776.00	1/4
07222	6 Way	4	-	6+6+6	4427.00	1/4
07223	4 Way	8	-	4+4+4	4240.00	1/4
07224	6 Way	8	-	6+6+6	4506.00	1/4
07225	8 Way	8	-	8+8+8	5154.00	1/4
07226	12 Way	8	-	12+12+12	6852.00	1/1

### AIR ECO DD (METAL) DB IP-42 TPN 63A PHASE SELECTOR (without rotary switch & wiring)

07230	4 Way (JR)	6	-	4+4+4	5112.00	1/1
07231	4 Way	8	-	4+4+4	5458.00	1/1
07232	6 Way	8	-	6+6+6	6337.00	1/1
07233	8 Way	8	-	8+8+8	7337.00	1/1
07234	12 Way	8	-	12+12+12	9108.00	1/1

### AIR ECO DD (METAL) DB IP-42 TPN PHASE SELECTOR (with 40A Rotary switch & wiring)

07236	4 Way (JR)	6	-	4+4+4	8978.00	1/1
07237	4 Way	8	-	4+4+4	9549.00	1/1
07238	6 Way	8	-	6+6+6	10672.00	1/1
07239	8 Way	8	-	8+8+8	11796.00	1/1

### AIR ECO DD (METAL) DB IP-42 TPN PHASE SELECTOR (with 63A Rotary switch & wiring)

07240	4 Way (JR)	6	-	4+4+4	9572.00	1/1
07241	4 Way	8	-	4+4+4	10369.00	1/1
07242	6 Way	8	-	6+6+6	11885.00	1/1
07243	8 Way	8	-	8+8+8	13098.00	1/1
07244	12 Way	8	-	12+12+12	15209.00	1/1

#### SPN /TPN DBs, Phase Selector DBs with & without Rotary Switches :

• Conforms to IS 8623-1 & 3, IEC 61439-1 & 3 • Reversible Door for IP-42 & IK-09 DBs. • Suitable for Surface & flush mounting. • Enclosure is made up of CRCA Sheet steel, RAL 9003 Powder coated. DBs includes 100A insulated Phase Bus-bar, Shrouded Neutral/Earth bar with Conditional short circuit Rating.

**SPN /TPN DBs :** This DB's kit includes high integrity accessories like Cement spill protector sheet, Colour-coded inter connecting wire set, Cable ties, Blank Module, Sticking saddles, Circuit identification labels.

• There is a provision for - 1) SPN: DP MCB / Isolator / RCCB/RCCBO as incomer & SP MCBs as outgoing.

2) TPN: FP MCB / Isolator / RCCB/RCCBO as incomer & SP/TP MCBs as outgoing.

**Phase Selector DBs with & without Rotary Switches :** DB has two separate compartments for MCB & Phase selector Switches • There is a provision for FP MCB / Isolator / RCCB/RCCBO as incomer & SP/TP MCBs as outgoing.

**Phase Selector DBs with Rotary Switches :** This DB's kit includes high integrity accessories like Cement spill protector sheet, Colour-coded inter connecting wire set, Cable ties, Blank Module, Sticking saddles, Circuit identification labels. • DB includes 3 Nos. of 40A/63A rotary switches, 3 Nos. of Rocker Switches for Phase identification.

### AIR ECO (METAL) ENCLOSURE IP-30

07251	2 Way	-	2	-	285.00	1/40
07252	4 Way	-	4	-	413.00	1/24

### AIR ECO DD (METAL) DB - IP42 - TV/TEL. ENCLOSURE Without TV Splitter & Tel. Crone Module NEW

07256	6 Way	-	-	-	-	1/12
07257	8 Way	-	-	-	-	1/8
07258	12 Way	-	-	-	-	1/8

### AIR ECO ROTARY SWITCH - SMALL SIZE NEW

07283	3 Way - 40A				775.00	1/40
07284	3 Way - 63A				950.00	1/40



Managing power was never so simple!



## Atlantic MCB

Automatically breaks the circuit if the current reaches a predetermined value

Code	Item	Pole	MRP ₹	Pkg. Outer/Master
<b>ATLANTIC MINIATURE CIRCUIT BREAKER - 10kA C' CURVE - SP</b>				
04301	6A MCB	1	251.00	10/200
04302	10A MCB	1	251.00	10/200
04303	16A MCB	1	251.00	10/200
04304	20A MCB	1	251.00	10/200
04305	25A MCB	1	251.00	10/200
04306	32A MCB	1	251.00	10/200
04307	40A MCB	1	473.00	10/200
04308	63A MCB	1	546.00	10/200
<b>ATLANTIC MINIATURE CIRCUIT BREAKER - 10kA C' CURVE - SPN</b>				
04311	6A MCB	2	683.00	6/120
04312	10A MCB	2	683.00	6/120
04313	16A MCB	2	683.00	6/120
04314	20A MCB	2	683.00	6/120
04315	25A MCB	2	683.00	6/120
04316	32A MCB	2	683.00	6/120
04317	40A MCB	2	1040.00	6/120
04318	63A MCB	2	1103.00	6/120
<b>ATLANTIC MINIATURE CIRCUIT BREAKER - 10kA C' CURVE - DP</b>				
04320	6A MCB	2	748.00	6/120
04321	10A MCB	2	748.00	6/120
04322	16A MCB	2	748.00	6/120
04323	20A MCB	2	748.00	6/120
04324	25A MCB	2	748.00	6/120
04325	32A MCB	2	748.00	6/120
04326	40A MCB	2	1103.00	6/120
04327	63A MCB	2	1197.00	6/120
<b>ATLANTIC MINIATURE CIRCUIT BREAKER - 10kA C' CURVE - TP</b>				
04330	6A MCB	3	1121.00	4/80
04331	10A MCB	3	1121.00	4/80
04332	16A MCB	3	1121.00	4/80
04333	20A MCB	3	1121.00	4/80
04334	25A MCB	3	1121.00	4/80
04335	32A MCB	3	1121.00	4/80
04336	40A MCB	3	1575.00	4/80
04337	63A MCB	3	1733.00	4/80
<b>ATLANTIC MINIATURE CIRCUIT BREAKER - 10kA C' CURVE - TPN</b>				
04340	6A MCB	4	1436.00	3/60
04341	10A MCB	4	1436.00	3/60
04342	16A MCB	4	1436.00	3/60
04343	20A MCB	4	1436.00	3/60
04344	25A MCB	4	1436.00	3/60
04345	32A MCB	4	1436.00	3/60
04346	40A MCB	4	1985.00	3/60
04347	63A MCB	4	2079.00	3/60





Code	Item	Pole	MRP ₹	Pkg. Outer/ Master
<b>ATLANTIC MINIATURE CIRCUIT BREAKER - 10kA C' CURVE - FP</b>				
04350	6A MCB	4	1586.00	3/60
04351	10A MCB	4	1586.00	3/60
04352	16A MCB	4	1586.00	3/60
04353	20A MCB	4	1586.00	3/60
04354	25A MCB	4	1586.00	3/60
04355	32A MCB	4	1586.00	3/60
04356	40A MCB	4	2195.00	3/60
04357	63A MCB	4	2300.00	3/60
<b>ATLANTIC ISOLATOR - DP</b>				
04360	40A Isolator	2	509.00	6/120
04361	63A Isolator	2	651.00	6/120
04362	100A Isolator	2	835.00	6/120
<b>ATLANTIC ISOLATOR - TP</b>				
04368	40A Isolator	3	746.00	4/80
04369	63A Isolator	3	919.00	4/80
04370	100A Isolator	3	1239.00	4/80
<b>ATLANTIC ISOLATOR - FP</b>				
04376	40A Isolator	4	1024.00	3/60
04377	63A Isolator	4	1187.00	3/60
04378	100A Isolator	4	1512.00	3/60
<b>ATLANTIC RCCB - 10kA - DP</b>				
04400	25A RCCB 30mA	2	2373.00	6/120
04401	25A RCCB 100mA	2	2405.00	6/120
04402	25A RCCB 300mA	2	2426.00	6/120
04403	40A RCCB 30mA	2	2583.00	6/120
04404	40A RCCB 100mA	2	2636.00	6/120
04405	40A RCCB 300mA	2	2667.00	6/120
04406	63A RCCB 30mA	2	3276.00	6/120
04407	63A RCCB 100mA	2	3339.00	6/120
04408	63A RCCB 300mA	2	3402.00	6/120

Code	Item	Pole	MRP ₹	Pkg. Outer/ Master
<b>ATLANTIC RCCB - 10kA - FP</b>				
04412	25A RCCB 30mA	4	2940.00	3/60
04413	25A RCCB 100mA	4	3098.00	3/60
04414	25A RCCB 300mA	4	3213.00	3/60
04415	40A RCCB 30mA	4	3098.00	3/60
04416	40A RCCB 100mA	4	3149.00	3/60
04417	40A RCCB 300mA	4	3276.00	3/60
04418	63A RCCB 30mA	4	3518.00	3/60
04419	63A RCCB 100mA	4	3644.00	3/60
04420	63A RCCB 300mA	4	3759.00	3/60
<b>ATLANTIC CHANGEOVER - DP</b>				
04430	25A Changeover	2	914.00	6/120
04431	32A Changeover	2	1155.00	6/120
04432	40A Changeover	2	1386.00	6/120
<b>ATLANTIC CHANGEOVER - FP</b>				
04435	25A Changeover	4	1859.00	3/60
04436	32A Changeover	4	2294.00	3/60
04437	40A Changeover	4	2809.00	3/60



Control, protect, and manage power with ease.



**homeguard**  
Main switch & Fuse units

The Homeguard fuse units protect against overloads & short circuits, cutting power during faults to prevent damage. They ensure safe maintenance, prevent electric shock, and offer easy ON/OFF control. Essential for safeguarding lives & property from electrical incidents, these devices are a crucial investment in safety.



Code	Item	MRP ₹	Pkg.
<b>PORCELAIN KIT-KAT FUSE</b>			
05101	16A / 240V	95.00	10/120
05102	16A / 415V (32A/240V)	158.00	10/80
05103	32A / 415V (63A/240V)	276.00	5/45
05104	63A / 415V	644.00	2/24



Code	Item	MRP ₹	Pkg.
<b>PORCELAIN KIT-KAT FUSE WITH HANDLE</b>			
05109*	32A / 415V	-	1/30
05110*	63A / 415V	-	1/12
05105	100A / 415V	1318.00	1/8
05106	200A / 415V	2286.00	1/6



Code	Item	MRP ₹	Pkg.
<b>PORCELAIN KIT-KAT FUSE WITH HANDLE &amp; BUSBAR LINK</b>			
05114*	63A / 415V	-	1/12
05115*	100A / 415V	-	1/8
05116*	200A / 415V	-	1/6
05107	300A / 415V	3574.00	1/3
05108	500A / 415V	4216.00	1/3



Code	Item	MRP ₹	Pkg.
<b>HRC FUSE HOLDER</b>			
05211	20 Amp	312.00	10/120
05212	32 Amp	402.00	10/120
05213	63 Amp	615.00	10/80
05214	125 Amp	1522.00	3/48



Code	Item	MRP ₹	Pkg.
<b>SWITCH FUSE UNIT (REWIRABLE) DP</b>			
05125	16A / 240V	846.00	1/18
05126	32A / 240V	1764.00	1/8
05134	32A / 415V	3359.00	1/4
05135	63A / 415V	6552.00	1/2



\* introducing shortly



Code	Item	MRP ₹	Pkg.
<b>SWITCH FUSE UNIT (REWIRABLE) TP</b>			
05127	16A / 415V	2597.00	1/6
05128	32A / 415V	3087.00	1/4
05129	63A / 415V	8297.00	1/2
05130	100A / 415V	14184.00	1/1
05131	200A / 415V	18827.00	1/1

Code	Item	MRP ₹	Pkg.
<b>SWITCH FUSE UNIT (REWIRABLE) TPN</b>			
05136	16A / 415V	3136.00	1/6
05137	32A / 415V	3584.00	1/4
05138	63A / 415V	9016.00	1/2
05139	100A / 415V	17360.00	1/1
05140	200A / 415V	22960.00	1/1

Code	Item	MRP ₹	Pkg.
<b>SHEET METAL CUT - OUT ENCLOSURE</b>			
05142	32A / 415V	672.00	1/20
05143	63A / 415V	1568.00	1/6
05144	100A / 415V	2548.00	1/4

Code	Item	MRP ₹	Pkg.
<b>L. T. CONTROL REVERSE FORWARD SWITCHES - PLASTIC HANDLE</b>			
05147	16A / 415V	585.00	1/24
05148	25A-32A / 415V	914.00	1/18

Code	Item	MRP ₹	Pkg.
<b>L. T. CONTROL REVERSE FORWARD SWITCHES - METAL HANDLE</b>			
05153	16A / 415V	806.00	1/24
05154	25A-32A / 415V	1148.00	1/18

Code	Item	MRP ₹	Pkg.
<b>CHANGEOVER SWITCH OFF LOAD - DP</b>			
05159	16A / 240V	1452.00	1/12
05160	32A / 240V	2036.00	1/8
05161	63A / 240V	7478.00	1/4
05162	100A / 240V	10527.00	1/1

Code	Item	MRP ₹	Pkg.			
				No of Modules		
				Incomer	Sub Incomer	Outgoing
<b>CHANGEOVER SWITCH OFF LOAD - TP</b>						
05171	16A / 415V	2206.00	1/6			
05172	32A / 415V	2695.00	1/6			

Code	Item	MRP ₹	Pkg.
<b>CHANGEOVER SWITCH OFF LOAD - FP</b>			
05183	16A / 415V	2695.00	1/6
05184	32A / 415V	3306.00	1/4
05185	63A / 415V	9313.00	1/2
05186	100A / 415V	14846.00	1/1

•High grade porcelain carrier fitted with tinned copper fuse wire  
•Switchgear enclosure made of CRCA sheet steel duly pre-treated and powder coated. •Hard bright tin plated contacts for high conductivity & longer life. •Quick make and break operating mechanism.

Code	Item	MRP ₹	Pkg.
<b>CHANGE OVER SWITCH OFF LOAD - FP KNIFE TYPE</b>			
05192*	63A / 415V	-	1/2
05193*	100A / 415V	-	1/1
05187	200A / 415V	26702.00	1/1
05188*	320A / 415V	-	1/1

•High grade porcelain carrier fitted with tinned copper fuse wire  
•Switchgear enclosure made of CRCA sheet steel duly pre-treated and powder coated. •Hard bright tin plated contacts for high conductivity & longer life. •Quick make and break operating mechanism.

Code	Item	MRP ₹	Pkg.
<b>AUTOMATIC CHANGEOVER SWITCH</b>			
05201	32A / 240V - 2 Pole	2782.00	1/8

•High grade porcelain carrier fitted with tinned copper fuse wire  
•Switchgear enclosure made of CRCA sheet steel duly pre-treated and powder coated. •Hard bright tin plated contacts for high conductivity & longer life. •Quick make and break operating mechanism.

Code	Item	MRP ₹	Pkg.
<b>CAM OPERATED ROTARY SWITCH</b>			
03232	3 Way - 25A	420.00	1/40
03233	3 Way - 32A	440.00	1/40
03234	3 Way - 40A	833.00	1/40
03235	3 Way - 63A	995.00	1/40

■ Modular construction ■ Enhanced life  
■ High Reliability ■ Aesthetic design  
■ Temperature withstand capability  
■ Voltage Impulse test

\* introducing shortly



SAFETY IS A PROCESS.  
IT STARTS WITH THE RIGHT PRODUCT.



**i-Secure 18**  
WiFi Video Door Phone  
  
Dimensions: 61x140x55 mm  
  
Code : WFDA0001ALU  
MRP ₹ : 13300.00  
Pkg. : 1



**i-Secure 09**  
7 Inch Analog door phone kit  
in White  
  
Dimensions: 196x132x20 mm (in-door)  
Dimensions: 49x135x42 mm (out-door)  
  
Code : VDPH0007WHIT  
MRP ₹ : 15000.00  
Pkg. : 1



**i-Secure 36**  
7 Inch IP video door phone kit  
in Black  
  
Dimensions: 199x139x23 mm (in-door)  
Dimensions: 62x136x28 mm (out-door)  
  
Code : VDIPH1007BLK  
MRP ₹ : 34200.00  
Pkg. : 1



**i-Secure 07**  
7 Inch Analog door phone kit  
in Silver  
  
Dimensions: 214x150x18 mm (in-door)  
Dimensions: 65x144x40 mm (out-door)  
  
Code : V DPR1007SLR  
MRP ₹ : 15000.00  
Pkg. : 1



# KNX Lifestyle Touch Panels & Push Buttons

Goldmedal is proud to present the world's most superior automation technology: the KNX Lifestyle Automation Solution.

Now, make your home smart and control it with ease, using the most modern, flexible, and stylish automation system available in the market. From young users to the oldest, every member in your family can use the soft touch push buttons, touch pads and switches to control every electrical aspect of your home. That's not all, they can even use their smart phones and tablets to control the system remotely from anywhere in the world.

The KNX Lifestyle Automation Solution incorporates all the latest technologies like DALI, Tunable White, RGB & RGB-W Control, Human Centric Lighting Control and is ready for all future upgrades.

From a single living room to a full commercial airport, Goldmedal's KNX Lifestyle Automation Solution has answers for all your automation needs. If you are thinking of automating your home or office, get in touch with us, now.



**Lifestyle 27**  
7" Wall Mounted Touch Screen



**Lifestyle 27**  
4" Wall Mounted Touch Screen



For order enquiries, please log into Dhan Barse App or call Customer Care at 91 9711 09 09 09. You can also write to us at [automation@goldmedalindia.com](mailto:automation@goldmedalindia.com).



**Lifestyle 09**  
Push Button with Room Temperature Control  
in Black Velvet



**Lifestyle 09**  
Push Button with 6 Switches  
in Beige Velvet



**Lifestyle 09**  
Push Button 8 Switches  
in Antique Copper



**Lifestyle 09**  
Push Button 12 Switches  
in Antique Bronze



**Lifestyle 07**  
3 Button Touch Switches  
in Alpine White



**Lifestyle 07**  
4 Button Touch Switches  
in Silver Streak



**Lifestyle 18**  
3 Button Touch Switches  
in Crystalline White



**Lifestyle 18**  
4 Button Touch Switches  
in Crystalline Black



Lifestyle 90  
Bluetooth Remote Control  
White



Lifestyle 90  
Bluetooth Remote Control  
Black

## IT'S A SWITCH. IT'S ALSO A REMOTE!

The GMesh remote controller is a switch-cum-remote control. You can fix it to a wall or a table and thus use it as a switch (wirelessly), or you can take it with you and use it as a remote control.

Goldmedal's GMesh technology gives you the comfort of a wired automation system without changing the existing wiring in your home. From switching to dimming to controlling fans and curtains, to RGB lighting control to tunable lighting control, everything is possible with GMesh. Add the Bluetooth based devices to your existing network and its done. You do not need a Wi-Fi or an Internet connection to control your room functions. Just switch on Bluetooth on your mobile phone and connect to your home network!

## Bluetooth Controller

G-Mesh products can handle DALI, Tunable White, RGB & RGB-W Control, Human Centric Lighting Control and is also ready for all future upgrades. While this may sound complex, it will surprise you to know that G-Mesh commissioning and set up is so simple that even a child can do it! Yes, even changing a lighting scenario is a simple task.



A2D0001 is a BLE-enabled 2 channel 0-10V or DALI controller. It has a universal 100-277V AC input voltage range and can control 2 separate analog channels, 1 Tunable White channel, or one Dali channel.



PWM0004 is a BLE-enabled four-channel PWM dimmer for constant voltage LED loads, such as LED strips and constant voltage LED modules. The same device can be used for both 12 and 24V DC LED strips. Separate drivers are not required for LED strip or RGB Strip dimming.



REL0004 is a BLE enabled 4 channel relay with 4 separate inputs to control BLE device on the network. The 4 inputs can be freely programmed to do operations like Dimming, curtains, master functions etc. The device can be used for curtain control also.



DCS0001 is a BLE-enabled DALI controller. It does not have its own power supply. Instead, it is powered directly from a DALI bus. DCS0001 can be used with a DALI sensor for presence detection or daylight harvesting or it can be used for controlling Human Centric Lighting (HCL).



TED0001 is a BLE-enabled trailing-edge dimmer for operation of incandescent lamps, dimmable LED lamps, and dimmable LED control gear. It can be installed in the ceiling, inside a luminaire, or into a ceiling outlet box.



ASD0001 is a BLE-control unit for LED drivers with 0-10V, 1-10V, or DALI dimming interface. The control output can be configured either as analogue 0-10V (and 1-10V) or as a digital standalone DALI control interface.



## Solutions to all your automation needs under one roof!

If you are planning to build a new home or a commercial building, you are bound to face a number of technical and financial challenges. These challenges have only grown with time. At Goldmedal, we present you a one-stop, complete home automation solution, under one roof.



Whether it's a single room, the entire house, a building, or a huge office complex, Goldmedal has the products and skills to automate them for you. Your goals can range from energy efficiency to increasing productivity to enhancing your lifestyle to a mix of other needs... we can tailor our solutions as per your demands.

The way you interact with your home or office can also be customized. Besides traditional interfaces like wall switches, push buttons, and touch panels, you can also control the automation through our mobile apps, smart phones, tablets, and smart watches.

With Goldmedal, the answers to all your home automation needs is just one call away!

Bringing our world closer to you!



## Experience the amazing - at your doorstep!

Presenting Goldmedal's Mobile Showroom - a never-before-seen concept in the world of wiring devices and accessories. Now, instead of visiting a showroom or a retail store, you can simply walk into this mobile store at a location nearest you. Designed by renowned automobile designer Dilip Chabria, this innovative yet thoughtfully crafted mobile showroom displays Goldmedal's latest products in a superbly premium environment.

There are multiple such mobile showrooms that ply the length and breadth of the country. You can track their movements online to check when one of them will be closest to your location. There are no reservations to be made. Just walk up to the mobile store and you will be welcomed with open doors! A Goldmedal executive in the showroom will be happy to assist you. We look forward to seeing you inside our amazing store!

### MOBILE SHOWROOM FEATURES

- LED Displays
- AC Environment
- Stylish, Ambient Light
- Multi Product Display
- Interactive Touch Screen
- Live GPS Tracking
- Executive Available



Goldmedal

## Walk in – and be amazed!

Walk into Goldmedal's Mobile Showroom and be ready to get amazed! This unique showroom on wheels proudly displays the latest and the most innovative products from the company in a contemporary and aesthetically appealing environment that you now associate with the Goldmedal brand.

We welcome you to touch, feel, and interact with each of the products on display. There is no time limit for your visit. If you have a question, an experienced Goldmedal executive will be at hand to provide you all the information you need.

## SHOWROOMS

WEST

### MUMBAI

E-1, Laxmi Industrial Estate,  
New Link Road,  
Andheri West, Mumbai - 400053  
Tel: +91-22-40031075  
Email: info@goldmedalindia.com

### AHMEDABAD

1106, Arista, 1st Floor, Opp Stellar,  
Sindhu Bhavan Road, Ahmedabad - 380058  
+91-8104965389  
Email: info@goldmedalindia.com

EAST

### KOLKATA

Merlin Homeland Mall, Shop No. 123, 1st Floor,  
18B, Ashutosh Mukherjee Road, Bhawanipore,  
Kolkata - 700 020. Tel: +91-8336956017  
Email: showroom.kolkata@goldmedalindia.co.in

### SILIGURI

International Market, 2nd Floor, Shop No. 3 & 4,  
Sevoke Road, Near Panitanki More,  
Beside Sky Star Building, Siliguri - 734001,  
West Bengal. Tel: +91-8336084284  
Email: ritesh.g@goldmedalindia.co.in

### GUWAHATI

1st Floor Patwari Enclave, Kachari Basti, Near Dispur  
Collage, Ganeshguri, Guwahati - 781005.  
Tel: +91-9718077070.  
Email: guwahati@goldmedalindia.com

### RANCHI

B Square, Plot no.189, Beside Girdhar Plaza,  
Harmu Road, Ranchi-834001.  
Tel.: +91-9431170402  
Email: ranchi@goldmedalindia.com

NORTH

### JODHPUR

Plot No. E-99A, M. I. A.  
Basni 2nd Phase, Jodhpur,  
Rajasthan - 342005.  
+91-9772210543  
Email: rajasthan@goldmedalindia.com

### NOIDA

H-204, Sec-63  
Noida, Uttar Pradesh - 201307  
Tel: +91-120-4135901  
Email: noida@goldmedalindia.com

### JAIPUR

Goldmedal Electricals Private Limited  
55, New Aatish Market, Mansarovar,  
Jaipur - Rajasthan.  
Tel: +91-291-3261955  
Email: rajasthan@goldmedalindia.com

### JALORE

Head Post Office Road,  
Jalore - 343001, Rajasthan, India.  
Tel: +91-2973222568  
Email: rajasthan@goldmedalindia.com

SOUTH

### HUBBALLI

Umachagi Complex, Koppikar Road, Hubballi,  
Karnataka-580020.  
Tel: +91-0836-4258466  
Email: bangalore@goldmedalindia.com

### BENGALURU

No. 6/2 & 6/3, Mysore Road, Near Satellite  
Bus Station, Bengaluru, Karnataka -560026.  
Tel: +91-80-41687799/41759977  
Email: bangalore@goldmedalindia.com

### HYDERABAD

4-1-690, Kothari Landmark, Old Vikranti Theatre,  
Mozamjahi Market, Hyderabad-500095,  
Telangana. Tel: +91-040-26706099  
Email: hyderabad@goldmedalindia.com

### VIJAYAWADA

2nd Floor, PVP Mall, Mahatma Gandhi Rd,  
Labbipet, Vijayawada-520010, Andhra Pradesh  
Tel: +91-9885676400  
Email: vijayawada@goldmedalindia.com

### VIJAYAWADA

D. NO. 11-33-15, Tatakulavari Street,  
Vijayawada-520 001, Andhra Pradesh  
Tel: +91-866-6542000 / 8977574737  
Email: vijayawada@goldmedalindia.com

### KADAPA

21/96, Reddy Complex, Near 7 Road Circle,  
Opp. Reddy Express, Kadapa- 516001, Andhra  
Pradesh.  
Tel: +91-9885676400  
Email: vijayawada@goldmedalindia.com

### CALICUT

Shaherzad Shopping Complex, CH Flyover Junction,  
Cherrooty Road, Calicut - 673001, Kerala.  
Tel: +91-9048743111  
Email: calicut@goldmedalindia.com

### COCHIN

3rd Floor, G K Arcade, Palarivattom Bye Pass Junction,  
Ernakulam - 682028, Kerala.  
Tel: +91-9497733334  
Email: calicut@goldmedalindia.com

### COIMBATORE

D. No. 897, Avinashi Road, Below Flyover,  
Coimbatore - 641018.  
Tel: +91-9324514945  
Email: chennai@goldmedalindia.com

## BRANCHES

WEST

### MUMBAI

119, Maskati Mahal, 3rd Floor, Room  
No.1- B. Loharchawl, Marine Line,  
Mumbai - 400002, Maharashtra, India.  
Tel: +91-22-39567558/511  
Mob.: 9320687515  
Email: marinelines@goldmedalindia.com

### REST OF MAHARASHTRA

Shakti Complex Building A, Unit No.  
1/2/3/4/5, Survey No.20, Hissa No.167,  
Vadunavghar Reti Bundar, Kaman  
Bhiwandi Road, Bhiwandi, 421302,  
Bhiwandi, Maharashtra, India.  
Tel: +91- 9152013168  
Email: maharashtra@goldmedalindia.com

### PUNE

CTS No 206-207, Ground Floor, Shop  
No.1, Shree Yash CHSL, Next to Yash  
Medical, Rasta Peth, Pune - 411011.  
Tel: +91-9822098620  
Email: pune@goldmedalindia.com

### AHMEDABAD

Block No. 43, Behind Savex Technologies  
Warehouse, Sanathal Bakrol Ring Road,  
Near Essar (Near Nayana) Petrol Pump,  
Village Badrabad, Ahmedabad,  
Gujarat- 382210  
Tel: +91-9372200393  
Email: ahmedabad@goldmedalindia.com

### BHOPAL

Way No. 11-12, Multi Industries  
Warehouse, Plot No. 13C, Industrial Area  
Govindpura, Bhopal,  
Madhya Pradesh - 462023  
Tel: +91-9589080144  
Email: bhopal@goldmedalindia.com

### RAIPUR

1st Floor, Plot No.15, Kedia Business Park,  
Tatibandh, Raipur - 492099,  
Chhattisgarh, India.  
Tel: +91-7714910078  
Email: raipur@goldmedalindia.com

EAST

### KOLKATA

KB 22, Bhakta Tower, 8th Floor,  
Salt Lake, Sector 3, Kolkata - 700098.  
Tel: +91-8336907040  
Email: kolkata@goldmedalindia.com

### PATNA

Khata No.144 To 149, Thana No. 20,  
Khesara No.30 To 31, mahadev Asthan,  
Tent City, Near Bypass Police Thana,  
Agamkuan, Patna-800009, Bihar, India.  
Tel: +91-9798606400  
Email: patna@goldmedalindia.com

### RANCHI

R S Plot No.2072, Near Dalaldali Chowk,  
Simaliya, P. S. Ratu, Ranchi - 834005,  
Jharkhand, India.  
Tel: +91- 9431170402  
Email: ranchi@goldmedalindia.com

### GUWAHATI

Ist Floor Patwari Enclave, Kachari Basti,  
Near Dispur Collage, Ganeshguri,  
Guwahati - 781005.  
Tel: +91- 9718077070.  
Email: guwahati@goldmedalindia.com

### CUTTACK

Plot No.1047 & 1048, Opp. Axis Bank,  
Jagatpur, Cuttack- 754021, Odisha  
(Orissa), India. Tel: +91- 9437452303  
Email: cuttack@goldmedalindia.com

NORTH

### JODHPUR

Plot no. E-99A, M. I. A.  
Basni 2nd Phase, Jodhpur,  
Rajasthan - 342005.  
Tel: +91-9772210543  
Email: rajasthan@goldmedalindia.com

### LUCKNOW

C1-5, Phase 2, Transport  
Nagar, Lucknow - 226012, U.P. India.  
Tel: +91-0522-3513741 & 8655997461  
Email: goldmedallucknow@goldmedalindia.co.in

### NOIDA

H-204, Sec-63, Noida,  
Uttar Pradesh - 201307  
Tel: +91-120-4135901  
Email: noida@goldmedalindia.com

SOUTH

### MOHALI

855/C, Janta Industrial Estate,  
Sector - 82, Mohali-160055,  
Punjab, India.  
Tel: +91-9814141991  
Email: mohali@goldmedalindia.com

### BENGALURU

No. 6/2 & 6/3, Mysore Road, Near Satellite  
Bus Station, Bengaluru, Karnataka -560026.  
Tel: +91-80-41687799/41759977  
Email: bangalore@goldmedalindia.com

### VIJAYAWADA

20-127/2, By Pass Road, Gollapudi,  
Krishna District, Vijayawada - 521225,  
Andhra Pradesh  
Tel: +91-866-6542333/6542888  
Email: vijayawada@goldmedalindia.com

### HYDERABAD

4-1-690, Kothari Landmark, Old Vikranti  
Theatre, Mozamjahi Market, Hyderabad-  
500095, Telangana.  
Tel: +91-040-26706099  
Email: hyderabad@goldmedalindia.com

### CHENNAI

92/6, Nattu Pillaiar Koil Street  
Sowcarpet, Chennai - 600001,  
Tamil Nadu, India.  
Tel: +91-44-49521008  
Email: chennai@goldmedalindia.com

### CALICUT

554-F & 554-G, Empirebuilding,  
Thenhippalam, Malappuram - 673636,  
Kerala,  
Tel: +91- 9497733334  
Email: calicut@goldmedalindia.com

# OUR CLIENTELE

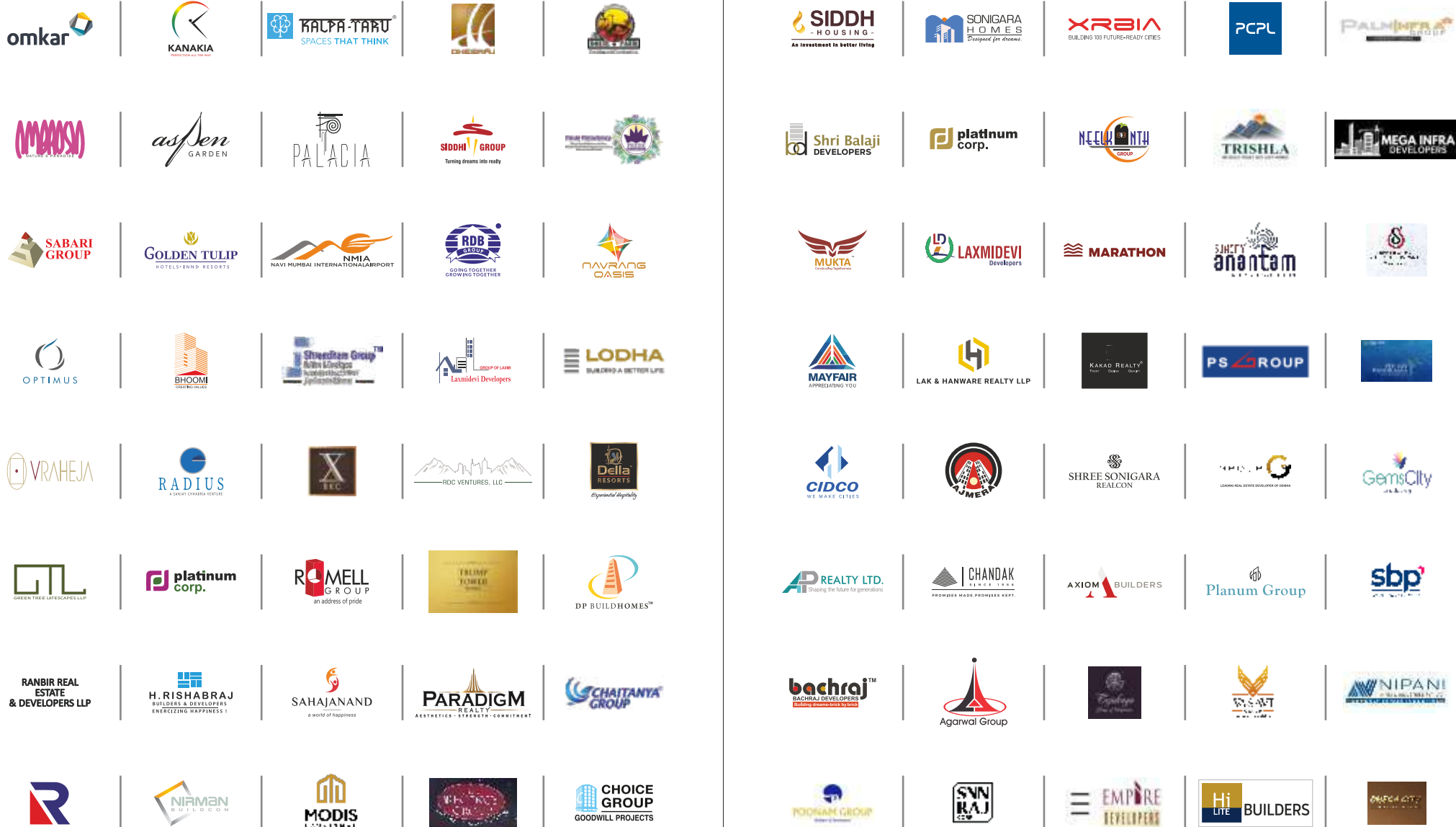

OUR CLIENTELE



OUR  
*amazing*  
headquarters

**63 GMA - Goldmedal Corporate Head Office**

Introducing Goldmedal's brand new corporate headquarters, a soaring symbol of innovation and productivity. Located at the heart of Mumbai's suburbs on S. V. Road, Goregaon West, this new business center of the company is well connected to the Western Express Highway, railway station, bus stops, and taxi stands. Home to the company's management and staff, 63 GMA has been designed with a captivating layered structure that harmoniously blends together to create a visually striking and architecturally pleasing building. Its innovative design encourages the entire Goldmedal workforce to work as a team toward a common mission.

The 31-storeyed glass façade headquarters has been designed to inspire creativity, foster collaboration, and drive productivity paving the way to a world of limitless possibilities. From open-plan areas to private offices, a sky garden, private decks, and spacious meeting rooms, this center offers versatile spaces that help teams to perform efficiently, making it a perfect place for work and play. For years, Goldmedal has pioneered the electrical industry by introducing cutting-edge technology and innovative products. The new headquarters of Goldmedal, equipped with state-of-the-art facilities and amenities, will continue to lead the company, ensuring a superior work environment that reflects the company's progress and success.

With 63 GMA, Goldmedal is all set to welcome a new era of innovation that will help unlock immense potential, achieve goals, and thrive in an environment that inspires greatness.

GMA  
**63**  
avenue



## NOTES

## NOTES

Brand Identity, Concept &  
Design copyright by  
GOLDMEDAL ELECTRICALS PVT. LTD.  
[www.goldmedalindia.com](http://www.goldmedalindia.com)

**Commercial Term & Conditions**

• All prices are in Indian Rupees (inclusive of GST) •  
Prices mentioned in this price list are of standard  
products • Warranty applicable on products are as  
per Goldmedal's warranty policy • Prices are  
subject to change without prior notice • This price  
list supersedes all previous price lists • Continuous  
design and product development is a routine  
practice at Goldmedal, so data in this price list  
provided may change without prior information or  
notice. Customers are advised to check current  
data before purchasing any product.