



Switch to the  
**amazing**

2018

PRODUCTS  
& PRICING MANUAL  
APR 2018 - ECOM01

[www.goldmedalindia.com](http://www.goldmedalindia.com)

Curv̄ Nixon  
ILLUMINATING IDEAS



# DESIGNED TO BE THE CENTRE OF EVERYONE'S ATTENTION.

A quick glance at the Ringo and you'll realize that it breaks all conventions for modular cover plates and accessories. With a unique circular slot for inserts and perfectly formed annular inserts to match, the Ringo is the choice for hard core stylists. **People who believe in following their own rules!**

**RINGO**   
THE CENTRE OF ATTRACTION

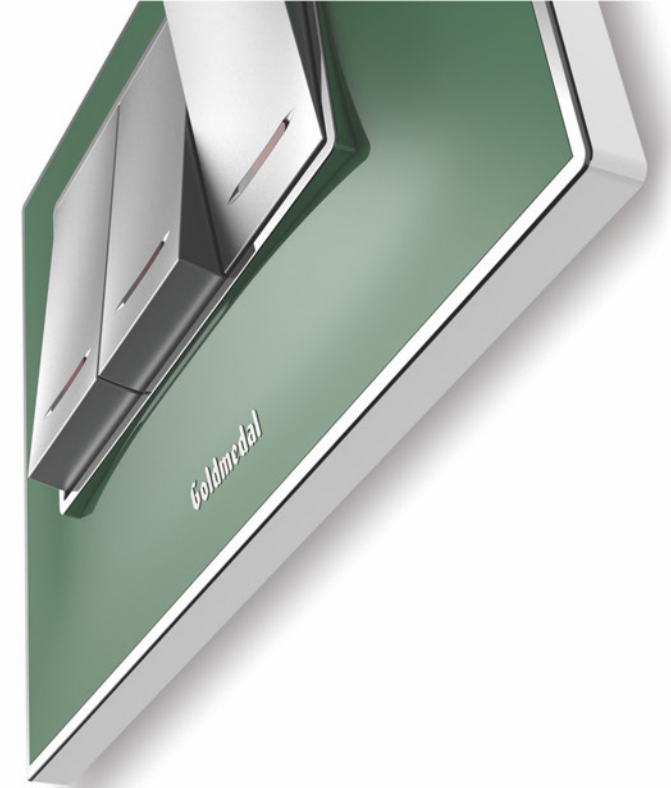
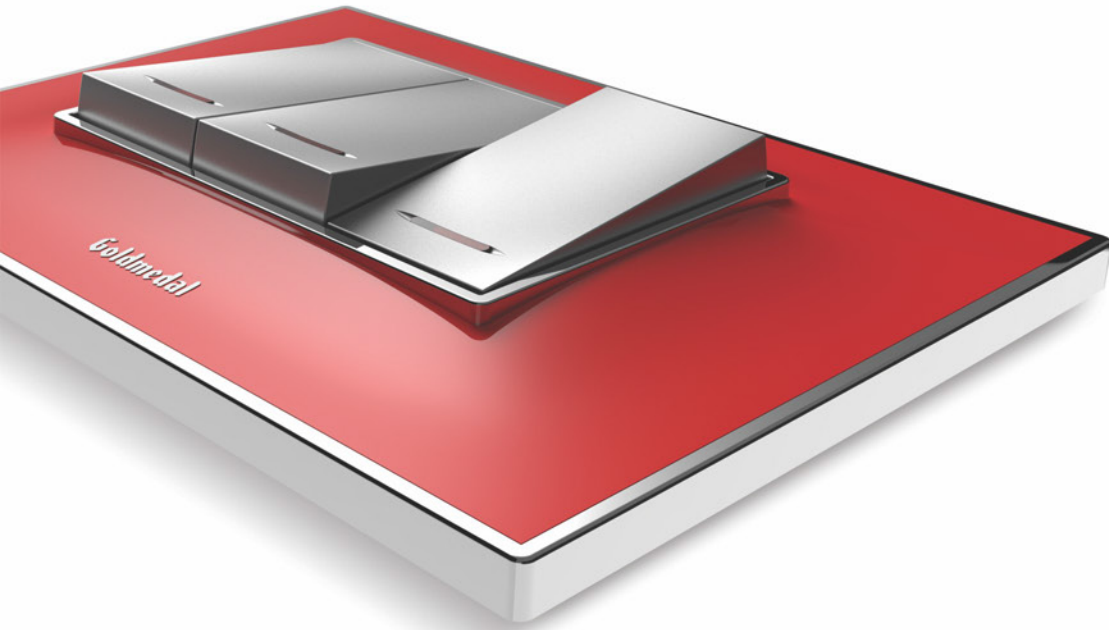

# WEGA

LOOKS GOOD FROM ANY ANGLE.

THE WEGA, WITH ITS SYMMETRICAL PEAKS AND SLOPES ON ALL FOUR SIDES, IS ANOTHER UNIQUE COVER PLATE FROM GOLDMEDAL. THE UNDULATING SHAPE CREATES AN INTERPLAY OF LIGHT THAT'S A DELIGHT TO THE SENSES. PLACE IT IN ANY SETTING AND IT'S SURE TO CATCH EVERYONE'S ATTENTION. FROM ANY ANGLE.

WEGA. GET READY TO BE MESMERIZED!



# Curvè

ILLUMINATING IDEAS

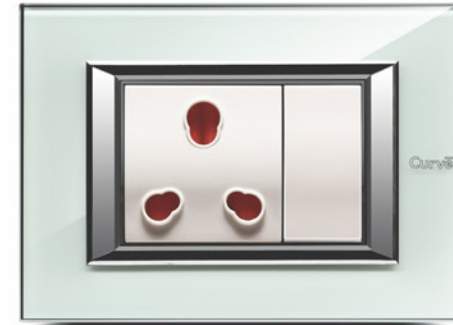

WHITE JAZZ

THE INSERTS GARBED IN WHITE JAZZ BRING IN A SOFT SOOTHING TONE TO THEIR FACADE. APART FROM UNLEASHING A CHASTE WHOLESOME AURA, THE GLOSSY SURFACE LAVISHES A MINIMALISTIC FEEL TO THE PRODUCT, MAKING IT BLEND SEAMLESSLY WITH THE SURROUNDINGS. ITS SUBTLE CHARM TOUCHES THE SIMPLICITY IN YOU, CREATING A DELIGHTFULLY SERENE FEELING. OPT FOR THESE INSERTS IF AUSTERITY IS YOUR FORTE.



DIGITAL CHROME

DIGITAL CHROME REPRESENTS A NEW IDIOM IN EXPRESSIVE LIVING. A REVOLUTIONARY SHADE, DIGITAL CHROME INSERTS PULSATE WITH A LUMINOSITY THAT MESMERISES THE SENSES. IDEAL FOR HOMES THAT EXHIBIT THE LATEST IN MODERN COMFORTS, THESE INSERTS POSSESS AN UNMISTAKABLE, ENDURING AURA. SAY YES TO THESE GILDED WORKS OF ART; EMBRACE THIS NEW PARADIGM THAT WILL SET THE TREND FOR THE FUTURE.



VOLTAGE GREY

VOLTAGE GREY, WITH ITS SOMBRE TONE, IMPARTS A REALISTIC FEEL TO YOUR INTERIORS. COUPLED WITH A DISTINCT SILKY TEXTURE THAT'S EMBELLISHED WITH A MATTE FINISH, THIS URBANE LINE OF ELECTRICAL FITTINGS EXUDES TECHNOLOGICAL AND AESTHETIC REFINEMENT. DESIGNED IN A SHADE THAT'S SUBTLE YET UNMISTAKABLY UNIQUE, VOLTAGE GREY BRINGS IN A RARE ENERGY TO YOUR DWELLINGS.

Code	Item	MRP ₹		Pkg.	Code	Item	MRP ₹		Pkg.
		White	Metallic/Grey				White	Metallic/Grey	
<b>6AX / 10AX SWITCHES 240V~ ( 1 Module )</b>					<b>20AMP SWITCHES 240V~ ( 3 Module )</b>				
101001	1 Way Switch	66.00	73.00	20	103029	1 Way Switch	155.00	170.00	10
101002	1 Way Switch with Indicator (LED)	118.00	130.00	20	103030	2 Way Switch	168.00	184.00	10
101003	2 Way Switch	118.00	130.00	20					
101004	Bell Push Switch	129.00	142.00	20					
101005	Bell Push Switch with Indicator (LED)	147.00	162.00	20					
<b>6AX / 10AX SWITCHES 240V~ ( 2 Module )</b>					<b>32AMP DP SWITCHES 240V~</b>				
102010	1 Way Switch	131.00	144.00	10	102031	DP Switch with Indicator (LED) - 2M	304.00	334.00	10
102011	1 Way Switch with Indicator (LED)	148.00	163.00	10	103033	DP Switch -3M	278.00	306.00	10
102012	2 Way Switch	164.00	180.00	10					
102013	Bell Push Switch	164.00	180.00	10					
102014	Bell Push Switch with Indicator (LED)	183.00	201.00	10					
<b>6AMP BELL PUSH 240V~ ( 2 Module )</b>					<b>6AMP / 6&amp;16AMP SOCKETS 240V~</b>				
102015	Bell Push with Luminous Name Plate 240V~ 50-60Hz LED circuit with diffuser	228.00	228.00	10	101035	6A 2 Pin Socket (1M) with safety shutter	106.00	117.00	20
					102036	6A 3 Pin Multi Socket (2M) with safety shutter	100.00	110.00	10
					102037	6A 2x1 Socket (2M) with safety shutter	122.00	134.00	10
					102039	10A International Socket (2M) with safety shutter	206.00	227.00	10
					102040	6A Universal Socket (2M) with mobile socket & safety shutter	137.00	151.00	10
					102041	6&16A Universal Socket (2M) with safety shutter	223.00	245.00	10
<b>6AX / 10AX SWITCHES 240V~ ( 3 Module )</b>					<b>25AMP / 6&amp;16AMP SOCKETS 240V~</b>				
103017	1 Way Switch	119.00	129.00	10	102042	25A 3 Pin Socket (2M) with safety shutter	245.00	270.00	10
103018	2 Way Switch	134.00	146.00	10	103043	6&16A Universal Socket (3M) with safety shutter	220.00	230.00	10
103019	Bell Push Switch	140.00	152.00	10					
<b>20AMP / 25 AMP SWITCHES 240V~ ( 1 Module )</b>					<b>DIMMERS 240 V~</b>				
101020	20A 1 Way Switch	157.00	173.00	20	101045	Dimmer (1M) 240V 50-60Hz 300-450W	269.00	296.00	20
101021	20A 1 Way Switch with Indicator (LED)	177.00	195.00	20	102046	Dimmer (2M) 240V 50-60Hz 300-450W	365.00	402.00	10
101022	20A 2 Way Switch	177.00	195.00	20	102047*	Dimmer (2M) 240V 50-60Hz 300-1000W	535.00	589.00	10
101023	25A 1 Way Switch	193.00	212.00	20					
<b>20AMP / 25AMP SWITCHES 240V~ ( 2 Module )</b>					<b>FAN REGULATOR 240V~</b>				
102025	1 Way Switch	184.00	202.00	10	101051	Step Regulator (1M) 4 Step, 240V 50-60 Hz	407.00	448.00	20
102026	1 Way Switch with Indicator (LED)	202.00	222.00	10	102052	Step Regulator (2M) 5 Step, 240V 50-60 Hz	440.00	484.00	10
102027	2 Way Switch	212.00	233.00	10	102052A	Step Regulator - Full Rotary (2M) 5 Step, 240V 50-60 Hz - Regulator Supplied in ISI & Non ISI	440.00	484.00	10
102028	25A 1 Way Switch	230.00	253.00	10					
					<b>MOTOR STARTER (SP) 240V~ 50-60Hz ( 2 Module )</b>				
					102056	10A Starter Switch	554.00	609.00	10
					102057	16A Starter Switch	554.00	609.00	10
					102058	20A Starter Switch	554.00	609.00	10
					102059	25A Starter Switch	554.00	609.00	10

\* introducing shortly

Code	Item	MRP ₹		Pkg.	Code	Item	MRP ₹		Pkg.
		White	Metallic/Grey				White	Metallic/Grey	
<b>TV SOCKET / RJ-11 TELEPHONE JACKS ( 1 Module )</b>					<b>FLOOR &amp; STEP LIGHT 240~ ( 4 Module )</b>				
101062	TV Socket Coaxial 40-862 Mhz Socket	129.00	142.00	20	120405	G-Focus Light ( Blue LED)	703.00	773.00	5
101069	RJ-11 Single Telephone Jack with Screw Terminal & Name Plate	120.00	132.00	20	120406	G-Focus Light Trio (LED) Fully recessed floor & step light with support frame & glassio cover plate with 3 color inbuilt LED Supply voltage 240V~50-60Hz	768.00	845.00	5
101070	RJ-11 Double Telephone Jack with Screw Terminal	151.00	166.00	20					
<b>EDP SOCKET OUTLET RJ-45 WITH NAME PLATE ( 1 Module )</b>					<b>ELECTRONIC HAND LAMP 240V~ ( 2 Module )</b>				
101072	EDP Socket Outlet - RJ 45 (Cat 5e) Category 5e, Universal wiring T568A, insulating-piercing terminal with shutter	211.00	232.00	20	102114	TORCIA Electronic hand lamp with high-efficiency 0.5W LED, automatic emergency device, rechargeable & replaceable Ni-MH battery, 2 hours operating range - Battery included (102115)	999.00	1099.00	5
101074	EDP Socket Outlet - RJ 45 (Cat 6e) Category 6e, Universal wiring T568A, insulating-piercing terminal with shutter	554.00	609.00	20	102115	Ni-MH 4.8V 80 mAh Battery (Spare parts)	229.00		10
<b>SINGLE POLE MCBS 240/450V~ ( 1 Module )</b>					101123	AAA Ni-MH 1.2V 1100 mAh without "memory" effect interchangeable - 3 Batteries set ( Spare parts )	379.00		10
101077	C6 SP MCB	279.00	307.00	20					
101078	C10 SP MCB	279.00	307.00	20					
101079	C16 SP MCB	279.00	307.00	20	<b>LIGHTING FITTING WITH EMERGENCY FUNCTION 240V~</b>				
101080	C20 SP MCB	279.00	307.00	20	102119	Lighting Fitting with Emergency Function (2M) with High Efficiency 2x0.5W LED	1022.00	1122.00	5
101081	C25 SP MCB	279.00	307.00	20	103121	Lighting Fitting with Emergency Function (3M) with High Efficiency 3x0.5W LED Supply voltage 240V~ 50Hz 3 Steps Dimming Switch 240V~ 50Hz When battery is inserted, the device will function as an emergency light - Batteries supplied separately (101124)	1375.00	1515.00	5
101082	C32 SP MCB 240/450V~ 50-60Hz 1.5kA Breaking Capacity	279.00	307.00	20					
<b>DOUBLE POLE MCBS 240/450V~ ( 2 Module )</b>					<b>EMERGENCY LIGHT BATTERY</b>				
102083	C6 DP MCB	577.00	635.00	10	101124	Battery Li-ion, 3.6V 600MAH 2/3A	249.00		10
102084	C10 DP MCB	577.00	635.00	10					
102085	C16 DP MCB	577.00	635.00	10	<b>BLANK MODULE/CORD GRIPPER/MOSQUITO REPELLENT ( 1M )</b>				
102086	C20 DP MCB	577.00	635.00	10	101125	Blank Module	27.00	29.00	50
102087	C25 DP MCB	577.00	635.00	10	101127	Cord Gripper (Output $\phi$ 9mm)	61.00	67.00	20
102088	C32 DP MCB 240/450V~ 50-60Hz 1.5kA Breaking Capacity	577.00	635.00	10					
<b>INDICATOR, FUSE UNITS ( 1 Module )</b>					<b>STEP MARKER LAMP ( 2 Module )</b>				
101093	Indicator with LED & Red Diffuser	107.00	118.00	20	102105	Step Marker Supply voltage 240V~ 50-60Hz with high-efficiency 1W LED & adjustable beam on three levels	521.00	573.00	5
101098	10 AMP Fuse Carrier with miniature fuse dia 6.3x28	150.00	165.00	20					

Code	Item	MRP ₹		Pkg.	Code	Item	MRP ₹		Pkg.
		White	Metallic/Grey				White	Metallic/Grey	
<b>ELECTRONIC BUZZERS ( 2 Module )</b>					<b>RF TOUCH SWITCHES</b>				
102138	Electronic Cuckoo Buzzer 240V~ 50-60Hz ( LED )	175.00	193.00	10	101206	RF 6A Touch Switch (1M) Supply voltage 160-240V~ 6A relay output Operating load (CFL & LED): 100W Max	1605.00	1766.00	5
102139	Electronic Bell 240V~ 50-60Hz ( LED )	300.00	331.00	10	102213	RF 6A Touch 2 Switch (2M) <b>NEW</b> Supply voltage 160-240V~ 6A relay output Operating load (CFL & LED): 100W Max (per switch)	2089.00	2298.00	5
<b>32A MAIN SWITCH ( 2 Module )</b>					102207	RF 20A Touch Switch (2M) Supply voltage 160-240V~ 20A relay output Operating load (CFL & LED): 200W Max Air conditioner: 2 ton  Radio Frequency : 433.92 Mhz Can also be operated by Remote control-103268 or web/mobile application via Gateway-101646	1847.00	2032.00	5
102163	32A DP Operated by Key Tag 240V~, LED Supplied with Key Tag	524.00	576.00	10	<b>RF TOUCH DIMMER / FAN REGULATOR ( 2 Module )</b>				
102164	Only Key Tag with Name Plate	105.00	116.00	20	102208	RF Touch Fan Regulator Supply voltage 160-240V~ Triac technology with 9 steps & digital display Operating load (Fan) : 100W	2217.00	2439.00	5
<b>25A ELECTRONIC BADGE SWITCH ( 3 Module )</b>					102214*	RF Touch Dimmer Supply voltage 160-240V~, Triac Technology with soft end & soft start function Operating load (LED) : 80W (Max) Incandescent Light: 40-450W Not suitable for Fan  Radio Frequency : 433.92 Mhz Can also be operated by Remote control-103268 or web/mobile application via Gateway-101646	2217.00	2439.00	5
103165	Electronic Switch with Smart Card 25A, 160-240V~ 50-60Hz with indicator (LED) & Integral relay having exit delay.	1529.00	1679.00	5	<b>RF TOUCH DRAPE CONTROLLER ( 2 Module )</b>				
103166	Smart Card Customizable Smart Card	115.00	-	20	102209	RF Drape Controller Supply voltage 160-240V~ 2.5A relay output Electronic RF Drape Controller suitable for AC Motor  Radio Frequency : 433.92 Mhz Can also be operated by Remote control-103268 or web/mobile application via Gateway-101646	2465.00	2630.00	5
<b>DND / MAKE MY ROOM</b>					<b>PASSIVE INFRARED DETECTOR</b>				
102168A	Do Not Disturb/Make My Room-2M 240V~ 50-60Hz - Outside Room	415.00	455.00	10	101210	Passive Infrared Detector (1M) with infrared sensor, adjustable dusk/dawn sensor threshold and time delay cycle, supply voltage 240V~ 50-60Hz, 6A relay output	1099.00	1209.00	5
102169A	Do Not Disturb/Make My Room-2M 240V~ 50-60Hz - Inside Room	445.00	489.00	10	<b>SMART PASSIVE INFRARED DETECTOR ( 2 Module )</b>				
<b>SHAVER SOCKET ( 4 Module )</b>					102212	Smart Passive Infrared Detector with infrared sensor, auto on/off, adjustable dusk/dawn sensor threshold and time delay cycle, supply voltage 240V~ 50-60Hz, 6A relay output	1616.00	1778.00	5
104171	Shaver Socket (4 Module) 240V~ 50-60Hz with isolating transformer output 110/240V~	1099.00	1209.00	5	<b>LPG / METANO GAS DETECTOR 240V~ ( 3 Module )</b>				
<b>USB CHARGER 240V~ ( 2 Module )</b>					103225	LPG / Metano Gas Detector Detector with acoustic and optical signaling and control on a solenoid valve, supply voltage 240V~50-60Hz  #please refer page no. 14 for wiring diagram & technical details.	2599.00	2799.00	5
102173	USB Charger - Single Port Supply voltage 160-240V~ 50-60Hz Output - 5V DC, 1A with inbuilt switch & dual colour LED indicator	1000.00	1102.00	5	<b>CRISTALLO SWITCH MEMORIO KNOB</b>				
102174	USB Charger - Double Port Supply voltage 160-240V~ 50-60Hz Output - 5V DC, 2A (Total)	1240.00	1355.00	5	101540	1 Module Switch Knob	11.00	-	50
					102541	2 Module Switch Knob	19.00	-	30
					103542	3 Module Switch Knob (with support knob)	29.00	-	20

Code	Item	MRP ₹		Pkg.
		White	Metallic/Grey	
<b>i-TOUCH RF BELL PUSH</b>				
102238	i-Touch Bell Push Switch (2M) <b>NEW</b> Supply voltage 160-240V-- 2A relay output	2300.00	2500.00	5
103245	i-Touch Bell Push Switch (3M) Supply voltage 160-240V-- 2A relay output	3800.00	4500.00	5
<b>i-TOUCH RF 20A SWITCH</b>				
102239	i-Touch 20A Switch (2M) <b>NEW</b> Supply voltage 160-240V-- , 20A relay output	3600.00	4000.00	5
103246	i-Touch 20A Switch (3M) Supply voltage 160-240V-- , 20A relay output Operating load (CFL & LED): 200W Max Air Conditioner: 2 ton Radio Frequency : 433.92 Mhz Can also be operated by Remote control-103268 or web/mobile application via Gateway-101646	5400.00	6200.00	5
<b>i-TOUCH RF SWITCHES ( 3 Module )</b>				
103244	i-Touch 4 Switch with Master Supply voltage 160-240V-- 6A relay output Operating load (CFL & LED):100W Max (per switch) Radio Frequency: 433.92 Mhz Can also be operated by Remote control-103268 or web/mobile application via Gateway-101646	5900.00	6900.00	5
<b>i-TOUCH RF LIGHT DIMMER ( 3 Module )</b>				
103248	i-Touch 2 Dimmer with Master Supply voltage 160-240V-- , Triac Technology with soft end & soft start function Operating load (LED): 80W (per dimmer) Incandescent Light: 40-450W (per dimmer) Radio Frequency : 433.92 Mhz <b>Not suitable for Fan</b> Can also be operated by Remote control-103268 or web/mobile application via Gateway-101646	4800.00	5500.00	5
<b>i-TOUCH RF SWITCHES &amp; FAN REGULATOR ( 3 Module )</b>				
103249	i-Touch 2 Switch + 1 Fan Regulator with Master Supply voltage 160-240V-- Switch: 6A relay output Operating load (CFL & LED): 100W Max (per switch) Fan Regulator: Variable Capacitance: based 5 steps speed Operating load (Fan): 100W Radio Frequency : 433.92 Mhz Can also be operated by Remote control-103268 or web/mobile application via Gateway-101646	6700.00	7600.00	5
<b>i-TOUCH RF DRAPE CONTROLLER ( 3 Module )</b>				
103252	i-Touch Drape Controller (2 Curtain) Supply voltage 160-240V-- 2.5A relay output (per channel) Electronic RF Drape Controller suitable for AC Motor Radio Frequency : 433.92 Mhz Can also be operated by Remote control-103268 or web/mobile application via Gateway-101646	4900.00	5700.00	5
<b>RF REMOTE ( RADIO FREQUENCY )</b>				
103268	RF Remote with Stand 2 Nos AAA 1.5V Battery Radio Frequency : 433.92 Mhz All scene setting can be done through the Remote. - Battery not included  # please refer page no.14 for i-touch wiring diagram & technical details.	-	1999.00	5

\* introducing shortly

## RF i-TOUCH / RF i-FEEL / RF TOUCH SYSTEMS

Installing i-Touch, i-Feel or Touch Switches does not require any new holes to be drilled or any additional wiring to be done. Simply plug them into your existing wiring. All i-Touch, i-Feel & Touch devices are designed with Switched Mode Power Supply (SMPS) for improved reliability, over current and over voltage protection. (For specific installation and technical details, please refer to the Technical Sheet provided within the product packaging). In case you need to upgrade, these electronic Touch devices can easily replace your existing Curve/Nixon modular switches.

### RF I-Touch 4 Switch + Master Switch (Wiring Diagram)

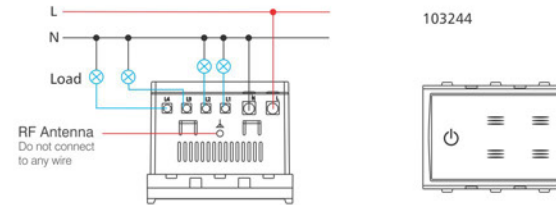

#### Technical Specifications

- Rated Voltage: 160-240V-- 50-60Hz
- Rated Load per Switch :
- a) Capacitive Load - CFL & LED (PF>0.8) : 100W
- b) Resistive Load - Incandescent & Halogen Lights: 1000 W
- c) Inductive Load - Fan and Motor : 800W
- Service Life: 50,000 Operations

### RF I-Touch 2 Switch + Fan Regulator (Wiring Diagram)

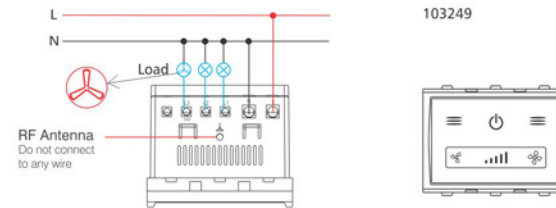

#### Technical Specifications

- Rated Voltage: 160-240V-- 50Hz
- Rated Load per switch:
- a) Capacitive Load - CFL & LED (PF>0.8) : 100W
- b) Resistive Load - Incandescent & Halogen Lights: 1000 W
- c) Inductive Load - Fan and Motor : 800 W
- Rated Load: Fan Regulator - Max 100 W
- 5-Level Speed Selection with Indicator
- Service Life: 50,000 Operations

### RF Touch Switch (Wiring Diagram)

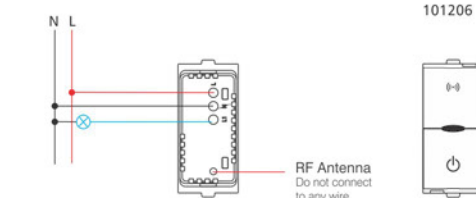

#### Technical Specifications

- Rated Voltage: 160-240V-- 50-60Hz
- Rated Load:
- a) Capacitive Load - CFL & LED (PF>0.8) : 100W
- b) Resistive Load - Incandescent & Halogen Lights: 1000 W
- c) Inductive Load - Fan and Motor : 800W
- Service Life: 50,000 Operations

### RF Touch Fan Regulator (Wiring Diagram)

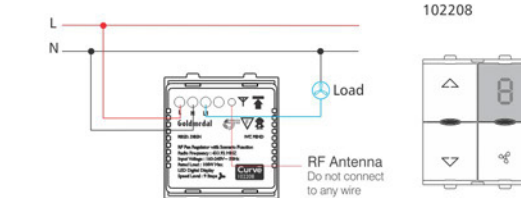

#### Technical Specifications

- Rated Voltage: 160-240V-- 50Hz
- Rated Load: Max 100 W.
- 9 Level Speed Selection
- 7 Segment Digital Display for Indicating Speed Level of the Fan.
- Service Life: 50,000 Operations

Wire colour codes: ■ Red (live),  
■ Black (neutral),  
■ Blue (load).





Code	Item	MRP ₹		Pkg.	Code	Item	MRP ₹		Pkg.
		White	Metallic/Grey				White	Metallic/Grey	
<b>MP4 PLAYER DETACHABLE ( 4 Module )</b>					<b>i - DOCK PLAYER ( 4 Module )</b>				
104271*	<p><b>Mp4 Player Detachable</b> Supply voltage 240V~ 2.8" wide screen TFT LCD Display, Feather Touch interface integrated with 8GB flash memory. Rechargeable lithium battery with audio playtime 20 hrs. Digital video playback, Music Player, FM Radio, E-book &amp; Photos</p> <p>USB cable &amp; stereo earphone included</p>	-	8400.00	5	104281	<p><b>i-Dock Player</b> Supply voltage 240V~ Inbuilt stereo amplifier : 2 x 4W, charging function for i-pod &amp; i-phone. Audio input - 3.5mm jack, i-pod, i-phone &amp; via Bluetooth Receiver (101283)</p> <p>Audio output - Stereo Line out, 2 Speaker out 4W each - Can be connected to any music system, home audio system, speakers i.e ceiling or inwall through amplifier via Line out (Aux out)</p> <p>- Amplifier supplied separately - 101320 - Bluetooth Receiver supplied separately - 101283</p> <p>Unit supplied with infrared Remote</p>	6100.00	6699.00	5
<b>BLUETOOTH PLAYER</b>					<b>BLUETOOTH RECEIVER (PORTABLE)</b>				
102273	<p><b>Bluetooth Player (2M)</b> Supply voltage 240V~ Bluetooth player with transmitter &amp; receiver. Multi colour LED to display different status</p> <p>Audio input - 3.5mm jack, Bluetooth (Rx mode)</p> <p>Audio output - Can be connected to bluetooth speaker or headphones in Tx mode (Input - Aux in) - Can be connected to any music system, home audio system, speakers i.e ceiling or inwall through amplifier via Line out</p> <p>Amplifier supplied separately - 101320</p>	4900.00	5600.00	5	101283	<p><b>Bluetooth Receiver ( Portable )</b> Made for i-pod &amp; i-phone docking Can be operated by any bluetooth device i.e. i-pod, i-phone, i-pad, Laptop, Mobile etc.</p>	-	2200.00	5
<b>BLUETOOTH &amp; FM PLAYER ( 8 Module )</b>					<b>STEREOPHONIC SPEAKER ( 2 Module )</b>				
108274	<p><b>Bluetooth &amp; FM Player with Speaker</b> Supply voltage 240V~ Mode selection -Aux (Line 1), Aux (Line 2), FM &amp; Bluetooth.</p> <p>Audio input - 3.5 jack (Front), Line In (Back), Bluetooth</p> <p>Audio output - Inbuilt Stereophonic Speaker 3W x 2 - Can be connected to any music system, home audio system, speakers i.e ceiling or inwall through amplifier via Line out</p> <p>Amplifier supplied separately - 101320</p>	5999.00	6499.00	5	102306	<p><b>Stereophonic Speaker - 2piece set</b> Stereophonic loud Speaker Load rating : 4W Impedance : 4 ohms</p>	1399.00	1599.00	10
<b>JUKE BOX ( 4 Module )</b>									
104277*	<p><b>Juke Box with Remote</b> Supply voltage 240V~ Touch Screen interface with inbuilt FM Radio, TFT with Multi Colour LCD display Micro SD Card slot, USB Drive 2.0 High speed.</p> <p>Audio input &amp; output - 3.5mm jack</p> <p>Audio output - Stereo Line out, 2 Speaker out 3W each - Can be connected to any music system, home audio system, speakers i.e ceiling or inwall through amplifier via Line out (Aux out)</p> <p>Amplifier supplied separately - 101320</p>	7200.00	8300.00	5					



# Nixon

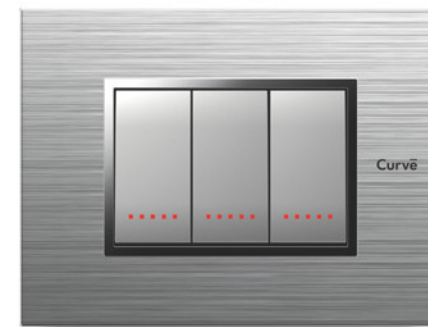

CLASSY AND MINIMALISTIC, THE NIXON RANGE OF MODULAR INSERTS PROJECTS A SLEEK, ELEGANT PRESENCE ON YOUR WALLS. MAGNIFYING THE SLEEKNESS ARE INSERTS IN DIGITAL SILVER, A REVOLUTIONARY NEW FINISH THAT PULSATES WITH LUMINOUS ENERGY. NIXON ALSO INTRODUCES A RANGE OF HIGH QUALITY LIFESTYLE PRODUCTS THAT WILL CHANGE THE WAY YOU LOOK AT MODULAR SWITCHES AND ACCESSORIES. ALL NIXON PRODUCTS ARE COMPATIBLE WITH CURVE MODULAR PLATES, MAKING THE POSSIBILITIES FOR FORM, FINISH AND COLOURS, SIMPLY ENDLESS.

Above shown product: Digital Silver Switches in Grazia Premium coverframe

Code	Item	MRP ₹		Pkg.	Code	Item	MRP ₹		Pkg.
		White	Metallic				White	Metallic	
<b>6AX / 10AX SWITCHES 240V~ ( 1 Module )</b>					<b>G-Click 6AX / 10AX SWITCHES 240V~ ( 1 Module )</b> <span style="color:red">NEW</span>				
101401	1 Way Switch	67.00	74.00	20	101751	1 Way Switch	74.00	-	20
101402	1 Way Switch with Indicator (LED)	123.00	135.00	20	101752	1 Way Switch with Indicator (LED)	135.00	-	20
101403	2 Way Switch	123.00	135.00	20	101753	2 Way Switch	135.00	-	20
101404	Bell Push Switch	131.00	144.00	20	101754	Bell Push Switch	144.00	-	20
101405	Bell Push Switch with Indicator (LED)	150.00	165.00	20	101755	Bell Push Switch with Indicator (LED)	165.00	-	20
<b>6AX / 10AX SWITCHES 240V~ ( 2 Module )</b>					<b>G-Click 6AX / 10AX SWITCHES 240V~ ( 2 Module )</b> <span style="color:red">NEW</span>				
102410	1 Way Switch	138.00	152.00	10	102760	1 Way Switch	152.00	-	10
102411	1 Way Switch with Indicator (LED)	156.00	172.00	10	102761	1 Way Switch with Indicator (LED)	172.00	-	10
102412	2 Way Switch	174.00	191.00	10	102762	2 Way Switch	191.00	-	10
102413	Bell Push Switch	174.00	191.00	10	102764	Bell Push Switch with Indicator (LED)	212.00	-	10
102414	Bell Push Switch with Indicator (LED)	193.00	212.00	10					
102415	Bell Push Switch with Luminous Name Plate	242.00	266.00	10					
	240V~ 50-60Hz LED circuit with diffuser								
<b>20AMP / 25AMP SWITCHES 240V~ ( 1 Module )</b>					<b>G-Click 20AMP / 25AMP SWITCHES 240V~ ( 1 Module )</b> <span style="color:red">NEW</span>				
101420	20A 1 Way Switch	164.00	180.00	20	101770	20A 1 Way Switch	180.00	-	20
101421	20A 1 Way Switch with Indicator	185.00	204.00	20	101771	20A 1 Way Switch with Indicator	204.00	-	20
101422	20A 2 Way Switch	185.00	204.00	20	101772	20A 2 Way Switch	204.00	-	20
101423	25A 1 Way Switch	200.00	220.00	20	101773	25A 1 Way Switch	220.00	-	20
<b>20AMP / 25AMP SWITCHES 240V~ ( 2 Module )</b>					<b>G-Click 20AMP / 25AMP SWITCHES 240V~ ( 2 Module )</b> <span style="color:red">NEW</span>				
102425	20A 1 Way Switch	190.00	209.00	10	102775	20A 1 Way Switch	209.00	-	10
102426	20A 1 Way Switch with Ind. (LED)	211.00	232.00	10	102776	20A 1 Way Switch with Ind. (LED)	232.00	-	10
102427	20A 2 Way Switch	228.00	251.00	10	102777	20A 2 Way Switch	251.00	-	10
102428	25A 1 Way Switch	242.00	266.00	10	102778	25A 1 Way Switch	266.00	-	10
<b>32AMP DP SWITCHES 240V~ ( 2 Module )</b>					<b>G-Click 32AMP DP SWITCHES 240V~ ( 2 Module )</b> <span style="color:red">NEW</span>				
102431	32A DP Switch with Indicator (LED)	327.00	360.00	10	102781	32A DP Switch with Indicator (LED)	360.00	-	10

Code	Item	MRP ₹		Pkg.	Code	Item	MRP ₹		Pkg.
		White	Metallic				White	Metallic	
<b>6AMP / 13AMP SOCKETS 240V~</b>									
101435	6A 2 Pin Socket (1M) with safety shutter	108.00	119.00	20					
102437	6A 2x1 Socket (2M) with safety shutter	130.00	143.00	10					
102439	13A International Socket (2M) with safety shutter	219.00	241.00	10					
102440	6A Universal Socket (2M) with mobile socket & safety shutter	148.00	163.00	10					
<b>6&amp;16AMP / 6&amp;25AMP SOCKETS 240V~</b>									
102441	6&16A Universal Socket (2M) with safety shutter	239.00	263.00	10					
102442	6&25A Universal Socket (2M) with safety shutter	258.00	284.00	10					
103443	6&16A Universal Socket (3M) with safety shutter	234.00	256.00	10					
<b>6 &amp; 16AMP SOCKET WITH FLAP - ( 2 Module )</b>									
102444	6&16A Universal Socket (2M) with flap & Indicator - 240V~ <b>NEW</b>	308.00	339.00	10					
<b>DIMMER / FAN REGULATOR 240 V~</b>									
101445	Dimmer 240V 50-60Hz 300-450W	304.00	334.00	20					
101451	Basic Step Regulator (1M) 4 Step, 240V 50-60 Hz	461.00	507.00	20					
102452	Basic Step Regulator (2M) 5 Step, 240V 50-60 Hz <b>IS-11037</b>	491.00	540.00	10					
	- Regulator Supplied with ISI & Non ISI								
<b>FAN REGULATOR 240V~ ( 2 Module )</b>									
102453	Galaxy Step Regulator - Half Rotary (Pure White) 5 Step, 240V 50-60 Hz	482.00	-	10					
102454	Galaxy Step Regulator - Full Rotary (Pure White) 5 Step, 240V 50-60 Hz <b>IS-11037</b>	482.00	-	10					
	- Regulator Supplied with ISI & Non ISI								
<b>FAN REGULATOR 240V~ ( 2 Module )</b>									
102453A	Galaxy Step Regulator - Half Rotary (Chrome Knob) 5 Step, 240V 50-60 Hz	504.00	554.00	10					
102454A	Galaxy Step Regulator - Full Rotary (Chrome Knob) 5 Step, 240V 50-60 Hz <b>IS-11037</b>	504.00	554.00	10					
	- Regulator Supplied with ISI & Non ISI								
<b>MOTOR STARTER (SP) 240V~ 50-60Hz ( 2 Module )</b>									
102456	10A Motor Starter Switch	593.00	652.00	10					
102457	16A Motor Starter Switch	593.00	652.00	10					
102458	20A Motor Starter Switch	593.00	652.00	10					
102459	25A Motor Starter Switch	593.00	652.00	10					
<b>TV SOCKET / RJ-11 TELEPHONE JACKS / EDP SOCKET ( 1 Module )</b>									
101462	TV Socket Coaxial 40-862 Mhz Socket	131.00	144.00	20					
101468	Telephone Jack - RJ 11	139.00	153.00	20					
101472	EDP Socket Outlet - RJ 45 (5e) Category 5e, Universal wiring T568A, insulating-piercing terminal	232.00	255.00	20					
101474	EDP Socket Outlet - RJ 45 (6e) Category 6e, Universal wiring T568A, insulating-piercing terminal	586.00	645.00	20					
<b>SINGLE POLE MCBS 240/450V~ ( 1 Module )</b>									
101477	C6 SP MCB	298.00	328.00	20					
101478	C10 SP MCB	298.00	328.00	20					
101479	C16 SP MCB	298.00	328.00	20					
101480	C20 SP MCB	298.00	328.00	20					
101481	C25 SP MCB	298.00	328.00	20					
101482	C32 SP MCB	298.00	328.00	20					
	240/450V~ 50-60Hz 3kA Breaking Capacity								
<b>DOUBLE POLE MCBS 240/450V~ ( 2 Module )</b>									
102483	C6 DP MCB	589.00	648.00	10					
102484	C10 DP MCB	589.00	648.00	10					
102485	C16 DP MCB	589.00	648.00	10					
102486	C20 DP MCB	589.00	648.00	10					
102487	C25 DP MCB	589.00	648.00	10					
102488	C32 DP MCB	589.00	648.00	10					
	240/450V~ 50-60Hz 3kA Breaking Capacity								
<b>G-POWER 25A UNIT ( 4 Module )</b>									
104491	G-Power 25A Unit (Metal Box) with Concealed Metal Junction Box (4M Plate with 25A MCB, 25A Socket & 16A G-grip Top)	839.00	929.00	5					
104492	G-Power 25A Unit (Plastic Box) with G-surface Plastic Gang Box (4M Plate with 25A MCB, 25A Socket & 16A G-grip Top) <b>NEW</b>	809.00	889.00	5					
	240/450V~ 50-60Hz 3kA Breaking Capacity								
<b>INDICATOR / FUSE UNIT / BLANK MODULE ( 1 Module )</b>									
101493	Indicator with LED & Red Diffuser	111.00	122.00	20					
101498	Fuse Carrier (10Amp/16Amp) with miniature fuse dia 6.3x28	150.00	165.00	20					
101525	Blank Module	29.00	31.00	50					

Code	Item	MRP ₹		Pkg.	Code	Item	MRP ₹		Pkg.
		White	Metallic				White	Metallic	
<b>STEP MARKER</b>									
102505	Step Marker (2M) Supply voltage 240V – 50-60Hz with high-efficiency 0.5W LED	NEW 521.00	573.00	5	102548	i-Touch Bell Push Switch Supply voltage 160-240V – 2A relay output	2300.00	2500.00	5
103506	Step Marker with Dimmable Function (3M)	1007.00	1107.00	5	102550	i-Touch 20A Switch Supply voltage 160-240V – 20A relay output Operating load (CFL & LED): 200W Max Air conditioner: 2 ton Radio Frequency : 433.92 Mhz  Can also be operated by Remote control-103268 or web/mobile application via Gateway-101646	3600.00	4000.00	5
102507	Step Marker with Dimmable Function (2M) Supply voltage 240V – 50-60Hz with high-efficiency 2x0.5W LED & 3 level dimmable function	745.00	820.00	5	<b>i-TOUCH RF DIMMER/FAN REGULATOR/DRAPE CONTROLLER ( 2M )</b>				
<b>LIGHTING FITTING WITH EMERGENCY FUNCTION</b>									
102510	Lighting Fitting with Emergency Function (2M) with High Efficiency 2x0.5W LED	1040.00	1119.00	5	102553*	i-Touch Light Dimmer Supply voltage 160-240V – Triac Technology with soft end & soft start function Operating load (LED) : 80W (Max) Incandescent Light: 40-450W Not suitable for Fan	3500.00	3800.00	5
103511	Lighting Fitting with Emergency Function (3M) with High Efficiency 3x0.5W LED Supply voltage 160-240V – 50Hz Dimmable function (3 Level) The device will function as an emergency light if battery is inserted - Battery supplied separately (101124)	1466.00	1583.00	5	102554	i-Touch Fan Regulator Supply voltage 160-240V – Variable Capacitance based 4 step regulator Operating load (Fan) - 100W	3500.00	3800.00	5
<b>EMERGENCY LIGHT BATTERY</b>									
101124	Battery Li-ion, 3.6V, 600mAh 2/3A	249.00	-	20	102556	i-Touch Drape Controller Supply voltage 160-240V – 2.5A relay output Electronic RF Drape Controller suitable for AC Motor Radio Frequency : 433.92 Mhz Can also be operated by Remote control-103268 or web/mobile application via Gateway:101646	3800.00	4200.00	5
<b>ELECTRO MECHANICAL BUZZER / ELECTRONIC BUZZER 240V ~</b>									
101530*	Electro Mechanical Buzzer (1M) 240V – 50-60Hz	156.00	171.00	20	<b>i-TOUCH DO NOT DISTURB/MAKE MY ROOM ( 2 Module )</b>				
102539	Electronic Bell (2M) 240V – 50-60Hz	NEW 361.00	397.00	10	102560	i-Touch DND / Make My Room / Please Wait (Inside Room)	2100.00	2500.00	5
<b>ELECTRONIC DOOR BELLS ( 4 Module )</b>									
104541*	Electronic Multi Tune Bell with 4 selectable melodies &  Supply voltage 240V – 50-60Hz,	NEW 1034.00	1150.00	5	102561	i-Touch DND / Make My Room / Please Wait with Bell Push Switch (Outside Room)  Supply voltage 160-240V – (Inside & outside unit are connected to each other)	2300.00	2700.00	5
<b>i-TOUCH RF SWITCHES / BELL PUSH ( 2 Module )</b>									
102544	i-Touch 2 Switch Supply voltage 160-240V – 6A relay output Operating load (CFL & LED): 100W Max (per switch) Radio Frequency : 433.92 Mhz Can also be operated by Remote control-103268 or web/mobile application via Gateway-101646	3500.00	3900.00	5	<b>32A MAIN SWITCH ( 3 Module )</b>				
102545	i-Touch Universal Switch Supply voltage 240V – - Can be paired wirelessly with any Goldmedal RF switch, fan regulator, dimmer etc. (Touch, i-Touch and i-Feel) as a two way switch - Can be configured as a switch for any particular scene or All ON or All OFF command	3900.00	4300.00	5	103562	32A DP Operated by Key Tag 240V –, LED Supplied with Key Tag For key tag please refer Curve product 102164	620.00	682.00	5
<b>32A MAIN SWITCH ( 2 Module )</b>									
102563	32A DP Operated by Key Tag 240V –, LED Supplied with Key Tag	577.00	635.00	10	102564	Only Key Tag with Name Plate	107.00	116.00	20
<b>25A ELECTRONIC BADGE SWITCH ( 3 Module )</b>									
103565	Electronic Switch with Smart Card 25A, 160-240V – 50-60Hz with indicator (LED) & Integral relay having exit delay. For smart card please refer Curve product 103166	1529.00	1679.00	5					

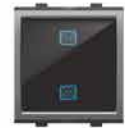

Code	Item	MRP ₹		Pkg.	Code	Item	MRP ₹		Pkg.
		White	Metallic				White	Metallic	
<b>BELL INDICATOR ( 6 Module )</b>									
106567	Bell Indicator for Call Display 6 Way with Name Plate 240V~	NEW	1699.00	1899.00	5				
<b>DND/MAKE MY ROOM 240~ ( 2 Module )</b>									
102568	Do Not Disturb/Make My Room 240V~ 50-60Hz - Inside Room		439.00	479.00	10				
102569	Do Not Disturb/Make My Room 240V~ 50-60Hz - Outside Room		469.00	509.00	10				
<b>USB CHARGER 240~</b>									
101572	USB Charger - (1M) Supply voltage 160-240V~ 50-60Hz		1000.00	1102.00	10				
102573	USB Charger - Double Port (2M) Supply voltage 160-240V~ 50-60Hz Output - 5V DC, 2A (Total)		1240.00	1355.00	5				
103574	USB Charger & 10A Int. Socket (3M) Supply voltage 160-240V~ 50-60Hz Output - 5V DC, 2A (Total)	NEW	1425.00	1565.00	5				
<b>AUDIO - VIDEO SOCKET ( 1 Module )</b> <span style="float: right;">NEW</span>									
101577	HDMI Socket		1000.00	1102.00	5				
101579	Triple RCA Socket (Audio & Video)		660.00	720.00	10				
<b>i-SENSE RF SWITCHES / DIMMER ( 2 Module )</b>									
102585*	i-Sense 4 Switch Feather Touch Electronic RF Switch 6A 240V~ relay output		-	6500.00	5				
102587*	i-Sense 2 Switch + 1 Dimmer Feather Touch Electronic RF Switch & Dimmer 6A 240V~ relay output Triac Technology with soft end & soft start function Operating load : 300-450W Radio Frequency : 433 Mhz Supply voltage 240V~ Can also be operated by Remote control-103268 or web/mobile application via Gateway-101646	NEW	-	6800.00	5				
<b>i-SENSE RF FAN REGULATOR / DRAPE CONTROLLER ( 2 Module )</b>									
102589*	i-Sense 2 Switch + 1 Fan Regulator Feather Touch Electronic RF Switch & Regulator 6A 240V~ relay output Moftset Technology with 5 steps fan coil speed Operating load (fan) : 100W		-	7300.00	5				
102591*	i-Sense Drape Controller (2Curtain) Feather Touch Electronic RF Drape Controller 6A 240V~ relay output Radio Frequency : 433 Mhz Supply voltage 240V~ Can also be operated by Remote control-103268 or web/mobile application via Gateway-101646	NEW		5700.00	5				
<b>i-SENSE HOME STATION &amp; TFT COLOUR DISPLAY ( 2 Module )</b>									
102596*	i-Sense Home Station Feather Touch Electronic Home Station Switching Lights, Operating Door, Call acceptance, Volume control of ringing tone.		-	8999.00	5				
102597*	i-Sense TFT Colour Display TFT Colour display with high quality picture even viewed at an angle Colour display switches on automatically when bell is actuated & can also be switch on manually Supply voltage 240V~	NEW	-	10999.00	5				
<b>CAMERA / IP CAMERA</b>									
102598*	Camera (2M) Automatic day/night switching, Camera can be manually swivelled 20° horizontally & vertically Automatic background lighting compensation. Automatic gain control (AGC) Protection type IP 44		-	8999.00	5				
103599*	IP Camera (3M) Automatic day/night switching, Camera can be manually swivelled 20° horizontally & vertically Automatic background lighting compensation. Automatic gain control (AGC) Supply voltage 160-240V~	NEW	-	14400.00	5				
<b>i-SENSE SENSO SWITCH ( 2 Module )</b>									
102601	i-Sense Senso Switch Supply voltage 160-240V~ 6A relay output Allows to control lights by simply passing the hand in front of it (Max distance 50mm). 2 units can be combined to control the same light (2 way function).	NEW	3999.00	4399.00	5				
<b>i-SENSE FM RADIO / BLUETOOTH PLAYER</b>									
102603*	i-Sense FM Radio (2M) Feather touch FM radio with digital display 87-50 MHz, 30 Station Memory with scanner		-	6100.00	5				
103604	i-Sense FM Radio / Bluetooth (3M) FM & Bluetooth player Mode selection : FM & Bluetooth. Audio output - Stereo Line out - Can be connected to any music system, home audio system, speakers i.e ceiling or inwall through amplifier via Line out, Supply voltage 240V~ - Amplifier supplied separately - 101320	NEW	7500.00	-	5				
<b>STEREPHONIC SPEAKER</b>									
102610*	Stereophonic Speaker (2M)		-	850.00	5				
103611*	Stereophonic Speaker (3M) Stereophonic Loud Speaker Load rating : 4W Impedance : 4 ohms		-	980.00	5				
<b>i-FEEL RF SWITCHES / BELL PUSH SWITCH ( 2 Module )</b>									
102626	i-Feel 2 Switch Supply voltage 160-240V~ , 6A relay output Operating load (CF & LED): 100W Max (per switch) Radio Frequency : 433.92 Mhz - Can also be operated by Remote control-103268 or web/mobile application via Gateway-101646		4500.00	5000.00	5				
102630	i-Feel Bell Push Switch Supply voltage 160-240V~ 2A relay output		3000.00	3300.00	5				

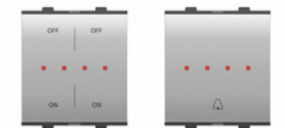
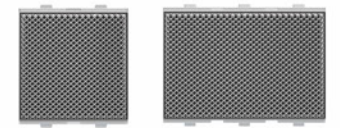
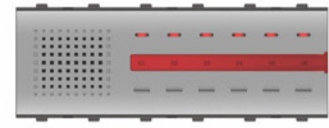

Code	Item	MRP ₹		Pkg.	Code	Item	MRP ₹		Pkg.
		White	Metallic				White	Metallic	
<b>i-FEEL RF 20A SWITCH ( 2 Module )</b>					<b>i-TOUCH WI-FI SWITCH ( 2 MODULE )</b> <span style="color:red">NEW</span>				
102632	<b>i-Feel 20A Switch</b> Supply voltage 160-240V~, 20A relay output Operating load (CFL & LED): 200W Max Air Conditioner: 2 ton Radio Frequency : 433.92 Mhz  Can also be operated by Remote control-103268 or web/mobile application via Gateway-101646	4700.00	5800.00	5	102661	<b>i-Touch - Wi-Fi 2 Switch</b> Supply voltage 160-240V~, 6A relay output Operating load (CFL & LED): 100W Max (per switch) Radio Frequency : 433.92 Mhz  Can also be operated by Remote control-103268 or via Wi-Fi Internet (without Gateway)	4400.00	4800.00	5
<b>i-FEEL RF DIMMER / FAN REGULATOR ( 2 Module )</b>					<b>i-TOUCH WI-FI 20A SWITCH ( 2 Module )</b> <span style="color:red">NEW</span>				
102634*	<b>i-Feel Light Dimmer</b> Supply voltage 160-240V~, Triac Technology with soft end & soft start function Operating load LED: 80W Incandescent Light: 40-450W <span style="color:red">NEW</span> Not suitable for Fan	4500.00	5000.00	5	102663	<b>i-Touch - Wi-Fi 20A Switch</b> Supply voltage 160-240V~, 20A relay output Operating load (CFL & LED): 200W Max Air conditioner: 2 ton Radio Frequency : 433.92 Mhz  Can also be operated by Remote control-103268 or via Wi-Fi Internet (without Gateway)	4500.00	5000.00	5
102636	<b>i-Feel Fan Regulator</b> Supply voltage 160-240V~ Variable Capacitance based 4 step regulator Operating load (Fan) : 100W Radio Frequency: 433.92 Mhz  Can also be operated by Remote control-103268 or web/mobile application via Gateway-101646	4500.00	5000.00	5	<b>i-TOUCH WI-FI DIMMER/FAN REGULATOR ( 2 Module )</b> <span style="color:red">NEW</span>				
<b>i-FEEL RF DRAPE CONTROLLER ( 2 Module )</b>					102666	<b>i-Touch Wi-Fi Dimmer</b> Supply voltage 160-240V~, Triac Technology with soft end & soft start function Operating load (LED) : 80W (Max) Incandescent Light: 40-450W Not suitable for Fan	4400.00	4800.00	5
102638	<b>i-Feel Drape Controller</b> Supply voltage 160-240V~ 2.5A relay output Electronic RF Drape Controller suitable for AC Motor Radio Frequency : 433.92 Mhz  Can also be operated by Remote control-103268 or web/mobile application via Gateway-101646	4600.00	5000.00	5	102667	<b>i-Touch Wi-Fi Fan Regulator</b> Supply voltage 160-240V~ Variable Capacitance based 4 step regulator Operating load (Fan) : 100W  Radio Frequency : 433.92 Mhz Can also be operated by Remote control-103268 or via Wi-Fi Internet (without Gateway)	4400.00	4800.00	5
<b>i-HOME AUTOMATION</b>					<b>i-TOUCH WI-FI DRAPE CONTROLLER ( 2 Module )</b> <span style="color:red">NEW</span>				
101646	<b>i-Home Gateway</b> - Compatible with RF Touch, i-Touch & i-Feel products. - Connects electrical functions through a router. - Control from anywhere using your smartphone / tablet / laptop / desktop. - Individual device control as well as scene settings. - Schedule individual devices as well as scenes	15999.00	-	1	102669	<b>i-Touch Wi-Fi Drape Controller</b> Supply voltage 160-240V~ 2.5A relay output Electronic RF Drape Controller suitable for AC Motor Radio Frequency : 433.92 Mhz  Can also be operated by Remote control-103268 or via Wi-Fi Internet (without Gateway)	4800.00	5300.00	5
					<b>i-TOUCH WI-FI SWITCH ( 3 MODULE )</b> <span style="color:red">NEW</span>				
					103673	<b>i-Touch - Wi-Fi 4 Switch with Master</b> Supply voltage 160-240V~, 6A relay output Operating load (CFL & LED): 100W Max (per switch) Radio Frequency : 433.92 Mhz  Can also be operated by Remote control-103268 or via Wi-Fi Internet (without Gateway)	6400.00	7000.00	5
					103676	<b>i-Touch - Wi-Fi 2 Switch + 1 Fan Regulator with Master</b> Supply voltage 160-240V~, 6A relay output Operating load (CFL & LED): 100W Max (per switch) Radio Frequency : 433.92 Mhz  Can also be operated by Remote control-103268 or via Wi-Fi Internet (without Gateway)	7900.00	8700.00	5



Code	Item	MRP ₹		Pkg.
		White	Digital Silver	
<b>SIGNAGE 240V~ 50-60Hz - ( 3 Module )</b>				
103647	Foot Light (LED) Supply voltage 240V~ 50-60Hz	569.00	639.00	5
103648	Step Marker (LED) Supply voltage 240V~ 50-60Hz	506.00	567.00	5
103649	LED Indicator Supply voltage 240V~ 50-60Hz	515.00	570.00	5
103650	LED Signage Supply voltage 240V~ 50-60Hz	515.00	570.00	5
<b>EDGE GLOW LED SIGNAGE 240V~ 50-60 Hz - ( 3 Module )</b>				
103652	Edge Glow LED Signage* Supply voltage 240V~ 50-60Hz	445.00	490.00	5
103653	Edge Glow Square Slide customizable symbol	205.00	-	5
103654	Edge Glow Rectangle Slide customizable symbol	225.00	-	5
103655	Edge Glow L Type Slide customizable symbol	255.00	-	5
* Edge Glow Slide Supplied Separately				

**SYMBOLS FOR CUSTOMIZABLE SLIDE OF EDGE GLOW LED SIGNAGE (LASER ENGRAVING)**

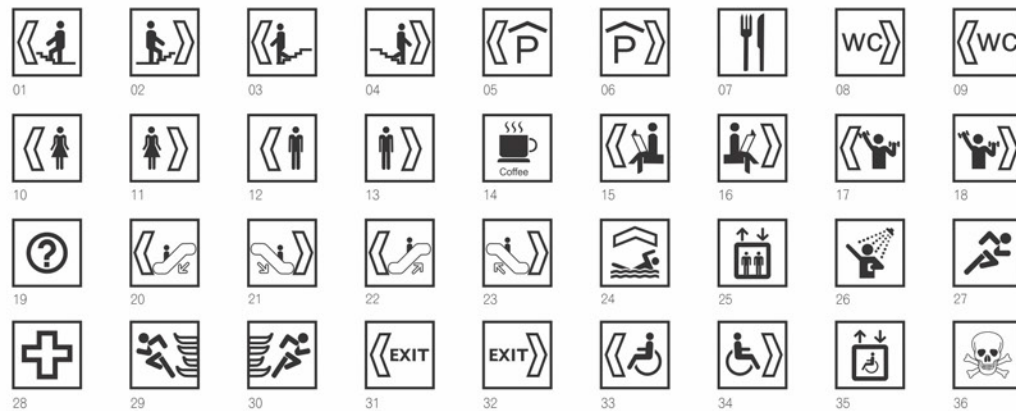















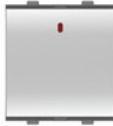
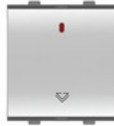
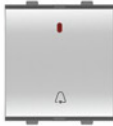

QUORRA XTREME BRUSHED ALUMINIUM WITH I-PUSH SWITCHES

THE I-PUSH IS A CONTEMPORARY TAKE ON CONVENTIONAL MECHANICAL SWITCHES WHERE YOU EXERT GENTLE PRESSURE TO OPERATE A SWITCH. UNLIKE ORDINARY SWITCHES, HOWEVER, THE I-PUSH SPRINGS BACK TO POSITION AND REMAINS FLUSH WITH THE COVER PLATE IN BOTH ON AND OFF POSITION. THE DISTINCT BUT SUBTLE CHANGE IN THE INDICATOR INFORMS THE USER ABOUT THE PREVAILING STATE OF THE SWITCH. SMART STYLING, LED AS WELL AS MECHANICAL INDICATORS, AND EXCITING SHADES MAKE THE I-PUSH RANGE A DELIGHT ON YOUR WALLS!



QUORRA XTREME BRUSHED ALUMINIUM WITH I-PUSH DP SWITCH

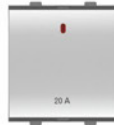
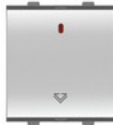

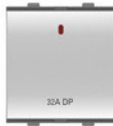
		Code	Item	MRP ₹		Pkg.			Code	Item	MRP ₹		Pkg.
				White	Metallic/Grey						White	Metallic/Grey	
			<b>6AX / 10AX i-PUSH SWITCHES 240V~ ( 1 Module )</b> <span style="color:red">NEW</span>										
			101681*	1 Way Switch	86.00	95.00	20						
			101682*	2 Way Switch	113.00	124.00	20						
			101683*	Bell Push Switch	119.00	131.00	20						
			<b>6AX / 10AX i-PUSH LED SWITCHES 240V~ ( 1 Module )</b> <span style="color:red">NEW</span>										
			101705*	1 Way Switch with Indicator (LED)	99.00	109.00	20						
			101706*	2 Way Switch with Indicator (LED)	130.00	143.00	20						
			101707*	Bell Push Switch with Indicator (LED)	137.00	151.00	20						
			<b>6AX / 10AX i-PUSH SWITCHES 240V~ ( 2 Module )</b> <span style="color:red">NEW</span>										
			102687*	1 Way Switch	129.00	142.00	10						
			102688*	2 Way Switch	157.00	173.00	10						
			102689*	Bell Push Switch	149.00	164.00	10						
			<b>6AX / 10AX i-PUSH LED SWITCHES 240V~ ( 2 Module )</b> <span style="color:red">NEW</span>										
			102711*	1 Way Switch with Indicator (LED)	148.00	163.00	10						
			102712*	2 Way Switch with Indicator (LED)	181.00	199.00	10						
			102713*	Bell Push Switch with Indicator (LED)	171.00	188.00	10						
		<b>20AMP i-PUSH SWITCHES 240V~ ( 1 Module )</b> <span style="color:red">NEW</span>											
			101693*	1 Way Switch	145.00	160.00	20						
			101694*	2 Way Switch	161.00	177.00	20						
		<b>20AMP i-PUSH LED SWITCHES 240V~ ( 1 Module )</b> <span style="color:red">NEW</span>											
			101717*	1 Way Switch with Indicator (LED)	167.00	184.00	20						
			101718*	2 Way Switch with Indicator (LED)	185.00	204.00	20						
		<b>20AMP i-PUSH SWITCHES 240V~ ( 2 Module )</b> <span style="color:red">NEW</span>											
			102697*	1 Way Switch	172.00	189.00	10						
			102698*	2 Way Switch	202.00	222.00	10						
		<b>20AMP i-PUSH LED SWITCHES 240V~ ( 2 Module )</b> <span style="color:red">NEW</span>											
			102721*	1 Way Switch with Indicator (LED)	198.00	218.00	10						
			102722*	2 Way Switch with Indicator (LED)	232.00	255.00	10						
	<b>32AMP i-PUSH DP SWITCH 240V~ ( 2 Module )</b> <span style="color:red">NEW</span>												
			102701*	32A DP Switch	315.00	347.00	10						
	<b>32AMP i-PUSH LED DP SWITCH 240V~ ( 2 Module )</b> <span style="color:red">NEW</span>												
			102725*	32A DP Switch with Indicator (LED)	362.00	398.00	10						

\* introducing shortly

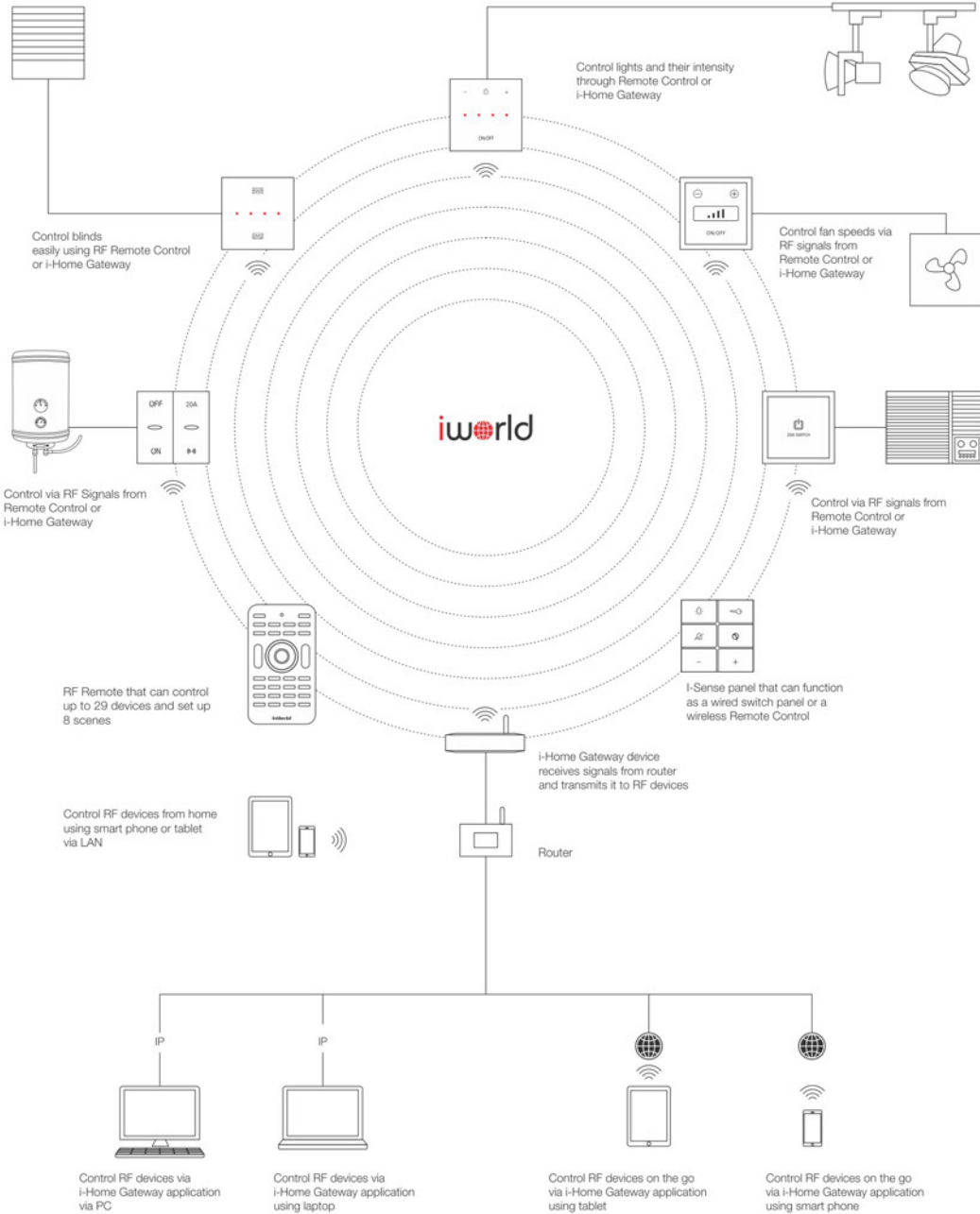

**i-HOME Automation**  
INTELLIGENT GATEWAY



YOUR WORLD,  
YOUR WAY.

WELCOME TO YOUR NEW, INTELLIGENT HOME!



Touch Products



i-Touch Products

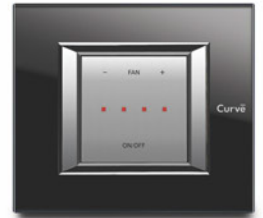

i-Feel Products

You have installed the latest Touch technology from Goldmedal in your home. Now, take it to the next level with the i-Home Gateway! From lights to fans to drapes and other functions, you can control individual devices, set scenes or even schedule the operations of scenes and devices using your smartphone, tablet, desktop or any smart mobile device ... from anywhere in the world.

**I-HOME GATEWAY**

The i-Home Gateway Router connects to your network in a few simple steps. Once connected, it captures commands from your smartphone, tablet, laptop or PC from anywhere in the world. The commands are then relayed to the relevant RF devices in the premises.

**SMARTPHONE**

Access the i-Home Gateway Application on the move on your Smart Phone, Tablet or PC. The intuitive interface enables you to set scenes, create timers and schedule devices as per your need!

**Goldmedal i-Home**

Download the Goldmedal i-Home App on your smart device to control your RF Switches from anywhere in the world. Download now!



Scan with your smartphone to download the user manual

Code	Item	MRP ₹	Pkg.	Code	Item	MRP ₹	Pkg.
<b>GALAXY RGB LED SPEAKER</b>				<b>KBSOUND® DOCK</b>			
101311	<b>Galaxy RGB LED Speaker</b> Load rating: 25W Impedance: 8 ohms  - Toughened glass for maximum safety - Amplifier supplied separately - Supplied with wireless RGB LED Controller - Supplied with touch RF remote.	10399.00	1	KB 50902	<b>KBSOUND DOCK</b> Wireless accessories for use with KBSOUND SPACE and KBSOUND iSELECT kit.  Contents: Dock (52591), Wireless Module (52592), RF Antenna and 5V power supply with interchangeable plugs for different countries  (When integrated with KBSOUND iSELECT you can enjoy the radio or listen to the music from your iPod, iPhone or additional sound source using a 3.5mm jack)	9999.00	1
<b>2 CHANNEL AMPLIFIER</b>				<b>KBSOUND® SPACE</b>			
101320	<b>2 Channel Amplifier</b> Power supply 110-240V~ Amplifier type BTL (class D) Output power max RL=4 ohms 35W per channel Treble (@20KHz) +- 12 db Bass (@40Hz) +- 12 db Frequency (-3 db) 25Hz-20KHz	4999.00	1	KB 50398	<b>KBSOUND SPACE</b> An open-ended model that allows you to freely choose your loudspeaker and amplifier to fulfil your specific design requirement.  Contents: <b>REMOTE CONTROL</b> - IR Remote control with display screen that shows RDS information and iPod/iPhone playing list. - Keypad to access different sound sources such as FM, iPod, Audio IN and DAB. - Allows you to control the volume, bass and treble levels, together with scanning and storing stations in the memory.  <b>ELECTRONIC MODULE (52398)</b> - Designed to incorporate the radio frequency device that permits integration with the KBSOUND DOCK. - Includes an improved antenna (RF) connector for better FM reception.  <b>IR RECEIVER / TRANSMITTER</b> - A separate IR bi-directional receiver/transmitter to communicate with the remote.	11800.00	1
<b>GIFA AUDIO HUB</b>				<b>KBSOUND® iSELECT KIT</b>			
GTX 501	<b>Audio Hub</b> (Wireless docking station + LED Lamp Speaker)  - Charging and Playback iPod models and iPhone - Plays MP3/WMA music through USB/SD/MMC card - Composite video out for iPod and iPhone - Aux in jack for Mp3 playback - DC-in Jack with AC/DC adaptor included - Docking station for iPod and iPhone - 2.4GHz wireless transmission - 85 white LED light - Back house with standard lamp E27 screw - 2.25" x 1 full range speaker - Control up to 8 group wireless devices  (Supplied with wireless LED lamp speaker GRX 501)	11599.00	1	KB 50302	<b>KBSOUND iSELECT (KIT)</b> A perfect sound system that allows you to hear FM radio and music from iPod/iPhone or 3.5mm Line IN when integrated with KBSOUND DOCK.  Contents: <b>REMOTE CONTROL</b> - IR Remote control with display screen that shows RDS information. - Keypad to access different sound sources such as FM, iPod, Audio IN and DAB. (when integrated with KBSOUND DOCK) - Allows you to control the volume, bass and treble levels, together with scanning and storing stations in the memory.  <b>ELECTRONIC MODULE (52391)</b> - Designed to incorporate any radio frequency device that permits integration with the KBSOUND DOCK. - Includes an improved antenna (RF) connector for better FM reception.  <b>TWO 2.5" LOUDSPEAKER</b> - 1.5W + 1.5W stereo output - IR reciever/transmitter built-in to loudspeaker grille <b>ANTENNA WIRE (76cm)</b> <b>PARALLEL LOUDSPEAKER CABLING (10M)</b>	10999.00	1
<b>GIFA AUDIO LIGHT</b>				<b>LOUDSPEAKERS i500 SERIES</b>			
GRX 501	<b>Audio Light</b> ( Wireless LED Lamp Speaker )  Music power: 20W Lighting power: 5W 2.25" x 1 full range speaker Digital Amplifier - 2.4GHz wireless transmission - 85 white LED light burns upto 30,000 hrs. - Back house with standard lamp E27 connector - Semi transparent cover with metal grill - Can be paired upto 8 group wireless devices  (Combine with GIFA Wireless docking GTX 501)	5999.00	1	KB 50301*	<b>Loudspeakers (Active &amp; Passive Speaker)</b>  <b>ACTIVE SPEAKER (55101)</b> - Data and sound (four channels) input line from the central unit. - 5+5W Sound Amplifier. - 8 Ohm two-way loudspeaker. - 8 Ohm output for Passive  * Introducing shortly	-	1
<b>I-ROCK BLUETOOTH SPEAKER</b>							
101351	<b>I-Rock Wireless Bluetooth Speaker</b> Bluetooth frequency: 2.40GHz-2.480 Ghz Operating Distance: 10 meters, class II Two speakers can be paired Working time: 16 hours (one speaker) Working time: 8 hours (When two speaker use together) Charging input: DC 12V  (12V DC Power adaptor included)	5999.00	1				



**BELLA COVER PLATES WITH MOUNTING FRAMES**

PLATES →	1M	2M	3M	3M*	4M	6M	7M*	8M(H)	8M*	8M (V)	8M(V)**	12M	16M	18M
COLOURS ↓	MRP ₹	MRP ₹	MRP ₹	MRP ₹	MRP ₹	MRP ₹	MRP ₹	MRP ₹	MRP ₹	MRP ₹	MRP ₹	MRP ₹	MRP ₹	MRP ₹
White Jazz	76.00	76.00	94.00	94.00	110.00	148.00	181.00	186.00	213.00	186.00	186.00	233.00	256.00	302.00
Metalik	97.00	97.00	126.00	126.00	143.00	186.00	239.00	243.00	266.00	243.00	243.00	306.00	310.00	338.00
Belle Soft	106.00	106.00	138.00	138.00	162.00	209.00	263.00	266.00	290.00	266.00	266.00	338.00	345.00	370.00
Antik	127.00	127.00	159.00	159.00	185.00	247.00	327.00	333.00	356.00	333.00	333.00	373.00	427.00	472.00
Belle Wood	127.00	127.00	159.00	159.00	185.00	247.00	327.00	333.00	356.00	333.00	333.00	373.00	427.00	472.00
CODE →	30101	30201	30301	33301	30401	30601	30701	30801	32801	38801	39801	31201	31601	31801
PKG →	10	10	10	10	10	5	5	5	5	5	5	5	5	5
SIZE(mm) →	93x86	93x86	119x86	125x86	151x86	219x86	219x86	268x86	246x86	154x155	152x168	220x155	268x155	225x224

COVER PLATES \* Without Partition \*\*8 Module Vertical Big Size

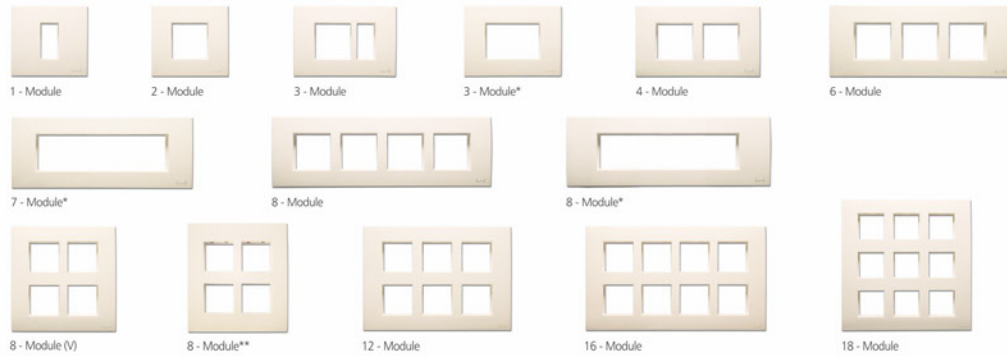

**CRISTALLO COVER PLATES WITH MOUNTING FRAMES**

PLATES →	1M	2M	3M	3M*	4M	6M	8M (H)	8M*	8M (V)	12M	16M	18M
COLOURS ↓	MRP ₹	MRP ₹	MRP ₹	MRP ₹	MRP ₹	MRP ₹	MRP ₹	MRP ₹	MRP ₹	MRP ₹	MRP ₹	MRP ₹
White Jazz	73.00	73.00	91.00	91.00	104.00	140.00	179.00	204.00	179.00	227.00	250.00	289.00
Memorio	169.00	169.00	203.00	203.00	245.00	313.00	426.00	426.00	426.00	469.00	563.00	642.00
Twixos/Metalik	145.00	145.00	187.00	187.00	215.00	265.00	320.00	320.00	320.00	390.00	435.00	499.00
Wood	170.00	170.00	221.00	221.00	258.00	304.00	375.00	375.00	375.00	457.00	508.00	569.00
CODE →	40101	40201	40301	43301	40401	40601	40801	42801	48801	41201	41601	41801
PKG →	10	10	10	10	10	5	5	5	5	5	5	5
SIZE(mm) →	92x86	92x86	115x86	122x86	150x86	222x86	264x86	248x86	150x151	222x151	264x151	223x217

COVER PLATES \* Without Partition

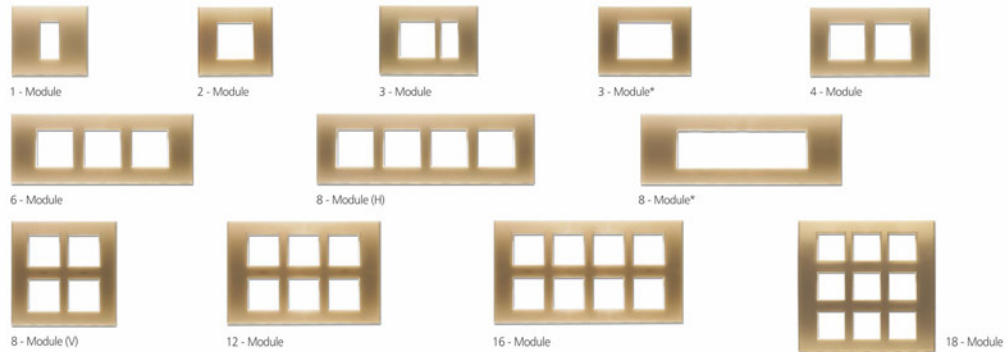

**QUORRA BASIC COVER PLATES**

PLATES →	1M	2M	3M	4M	NEW		NEW		NEW		12M	16M	18M	
					4M*	6M	6M*	8M (H)*	8M	8M*				8M (V)
COLOURS ↓	MRP ₹	MRP ₹	MRP ₹	MRP ₹	MRP ₹	MRP ₹	MRP ₹	MRP ₹	MRP ₹	MRP ₹	MRP ₹	MRP ₹	MRP ₹	MRP ₹
Satin White	-	102.00	129.00	160.00	-	207.00	-	248.00	248.00	-	248.00	314.00	438.00	
Metallic	-	168.00	186.00	219.00	-	263.00	-	318.00	318.00	-	318.00	439.00	538.00	
Wood	-	197.00	219.00	274.00	-	318.00	-	395.00	395.00	-	395.00	538.00	714.00	
CODE →														
PKG →														
SIZE(mm) →		101x87	124x87	148x87		222x87		271x87	248x87		148x154	222x154	222x220	

**QUORRA EXCLUSIVE COVER PLATES**

Glass	-	339.00	488.00	649.00	-	914.00	-	994.00	994.00	-	994.00	1199.00	1469.00
CODE →													
PKG →													
SIZE(mm) →													

**QUORRA PREMIUM COVER PLATES**

Glass	435.00	435.00	615.00	810.00	890.00	1090.00	1200.00	-	1230.00	1350.00	1230.00	1455.00	1765.00
CODE →	50101	50201	53301	50401	50403	50601	50603	50801	52801	50803	58801	51201	51801
PKG →	10	10	10	10	10	5	5	5	5	5	5	5	5
SIZE(mm) →	106x91	106x91	128x91	152x91	152x91	226x91	226x91	-	251x91	269x91	152x157	226x157	226x224

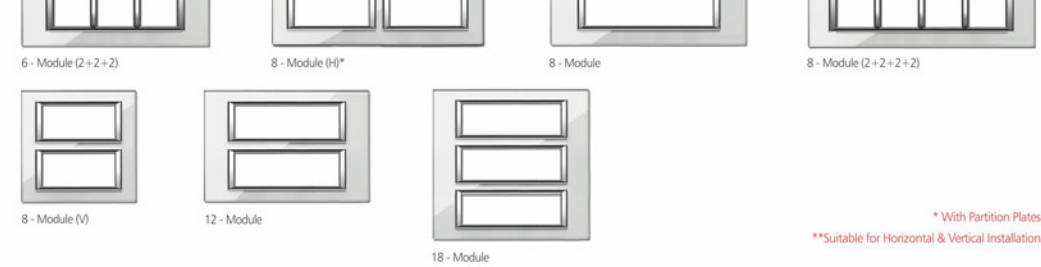

\* With Partition Plates  
\*\* Suitable for Horizontal & Vertical Installation

**QUORRA MOUNTING FRAME - Horizontal & Vertical Distance for Screwing ( Dimensions in mm )**

Quorra Frame →	2M	3M	4M	4M	6M	6M	8M (H)*	8M	8M	8M (V)	12M	18M
MRP ₹ →	49.00	59.00	68.00	72.00	99.00	107.00	124.00	124.00	134.00	124.00	159.00	216.00
CODE →	50202	53302	50402	50404	50602	50604	50802	52802	50804	58802	51202	51802
PKG →	25	25	25	25	20	20	20	20	20	20	20	10

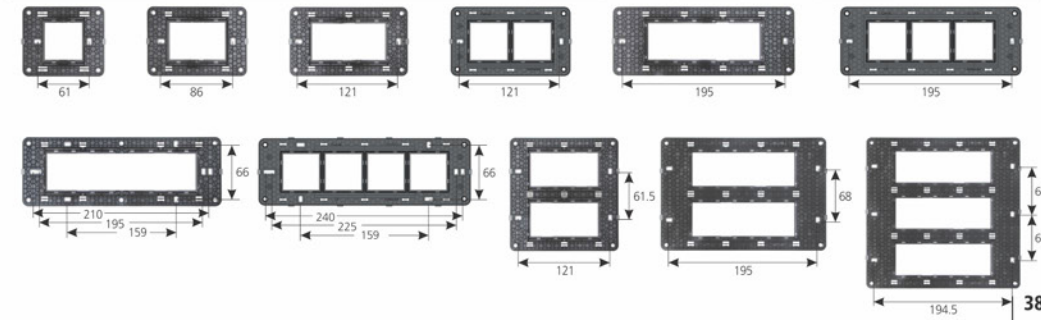

QUORRA CRYSTALLIGHT / DIAMOND COVER PLATES											
PLATES →	1M	2M	3M	4M	NEW	NEW	NEW	8M*	8M (V)	12M	18M
					4M*	6M*	8M*				
COLOURS ↓	MRP ₹	MRP ₹	MRP ₹	MRP ₹	(H&V)**	(H&V)**	(H&V)**	MRP ₹	MRP ₹	MRP ₹	MRP ₹
Glass (diamond cut)	490.00	490.00	690.00	910.00	1000.00	1300.00	1380.00	1460.00	1520.00	1460.00	2010.00
Diamond (studded)	-	-	4399.00	-	-	-	-	-	-	-	-

QUORRA XTREME COVER PLATES												
Wood	410.00	410.00	588.00	777.00	855.00	1103.00	1192.00	1263.00	1317.00	1263.00	1449.00	1775.00
Steel	494.00	494.00	704.00	935.00	1028.00	1323.00	1433.00	1525.00	1582.00	1525.00	1733.00	2132.00
Aluminum	494.00	494.00	704.00	935.00	1028.00	1323.00	1433.00	1525.00	1582.00	1525.00	1733.00	2132.00
CODE →	50101	50201	53301	50401	50403	50601	50603	52801	50803	58801	51201	51801
PKG →	10	10	10	10	10	5	5	5	5	5	5	5
SIZE(mm) →	106x91	106x91	128x91	152x91	152x91	226x91	226x91	251x91	269x91	152x157	226x157	226x224

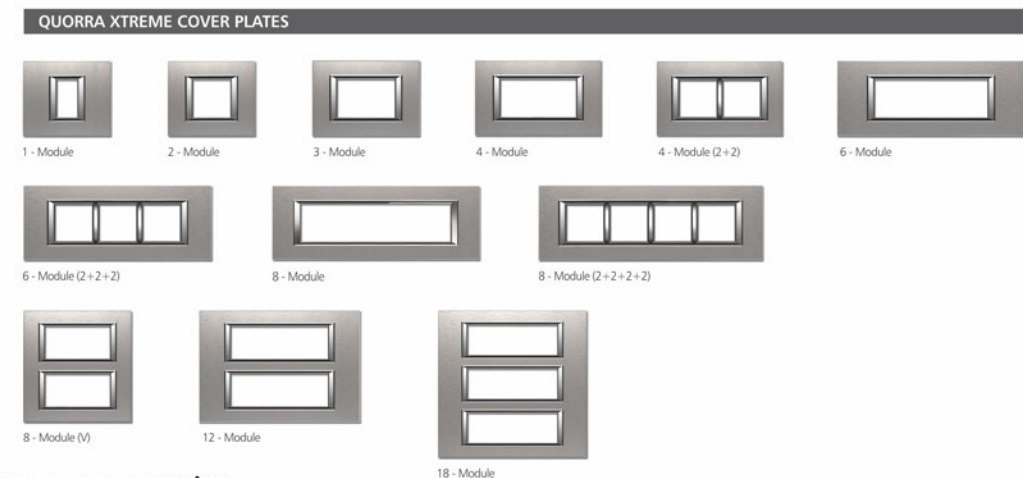
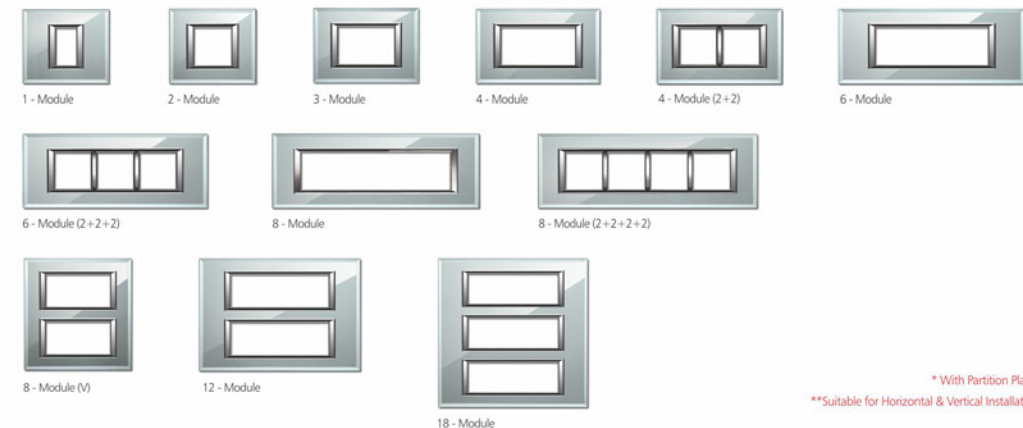

GRAZIA BASIC COVER PLATES WITH MOUNTING FRAMES																
PLATES →	1M	2M	3M	3M*	4M	NEW	NEW	NEW	8M*	8M (V)	9M*	12M	12M*	12M*	16M	18M
						4M*	6M*	8M*								
COLOURS ↓	MRP ₹	MRP ₹	MRP ₹	MRP ₹	MRP ₹	MRP ₹	MRP ₹	MRP ₹	MRP ₹	MRP ₹	MRP ₹	MRP ₹	MRP ₹	MRP ₹	MRP ₹	MRP ₹
Pure Glossy	79.00	79.00	97.00	97.00	120.00	120.00	171.00	171.00	215.00	215.00	215.00	230.00	246.00	246.00	273.00	312.00
Metallic	114.00	114.00	148.00	148.00	181.00	181.00	247.00	247.00	309.00	309.00	309.00	331.00	361.00	361.00	397.00	399.00
Wood	151.00	151.00	206.00	206.00	252.00	252.00	344.00	344.00	470.00	470.00	470.00	474.00	482.00	482.00	529.00	562.00

GRAZIA PREMIUM COVER PLATES WITH MOUNTING FRAMES																	
Pure Glossy	92.00	92.00	114.00	114.00	139.00	139.00	199.00	199.00	252.00	252.00	252.00	270.00	288.00	288.00	324.00	367.00	
CODE →	60101	60201	60301	60303	60401	60404	60601	60604	60801	60804	68801	60901	61201	61204	61207	61601	61801
PKG →	10	10	10	10	10	10	5	5	5	5	5	5	5	5	5	5	5
SIZE(mm) →	101x93	101x93	124x93	124x93	148x93	154x93	221x93	226x93	247x93	280x93	148x159	280x93	222x160	226x160	226x160	246x159	222x226

\* With Partition Plates    \*\*Suitable for Horizontal & Vertical Installation



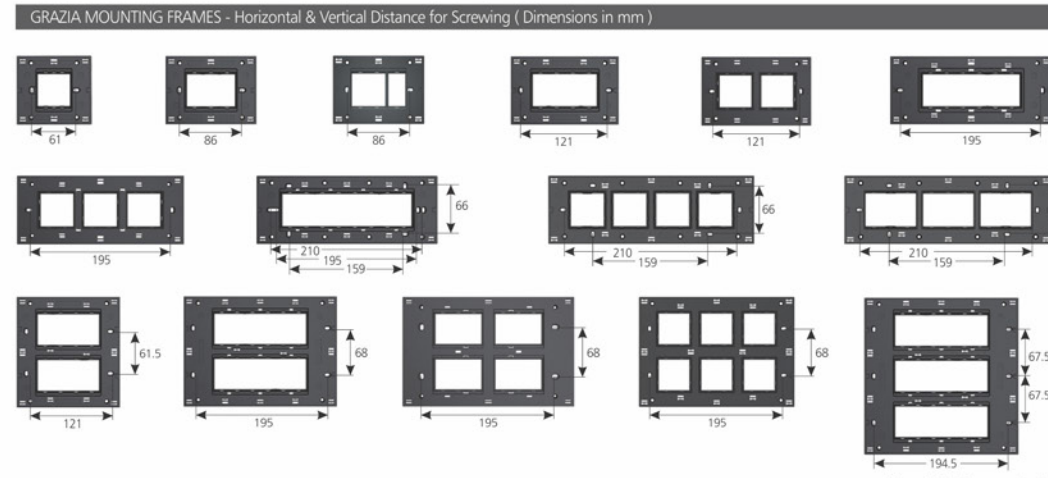
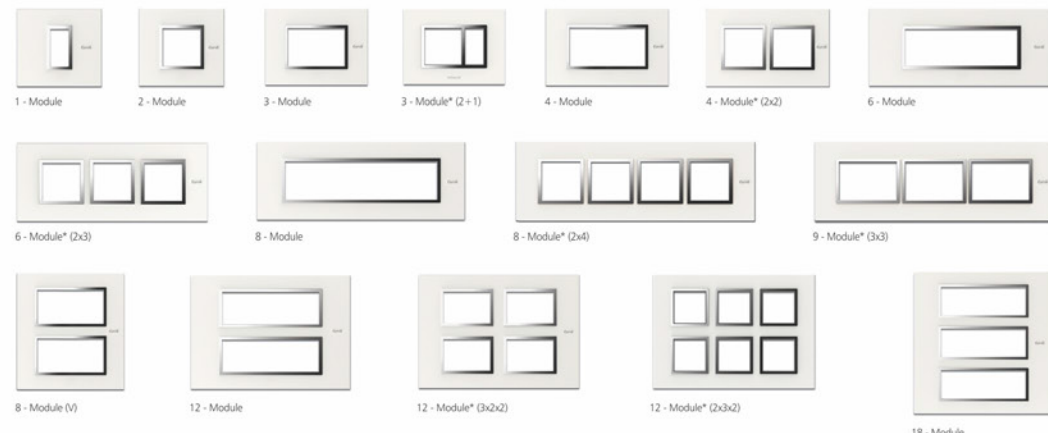

# WEGA

UNCONVENTIONAL YET PERFECTLY SYMMETRICAL, BOLD YET ELEGANT - THE WEGA COVER PLATES ARE STUNNING IN EVERY WAY. AN EXAMPLE OF IMAGINATION AND ENGINEERING PRECISION OF THE HIGHEST ORDER, THE WEGA, WITH ITS DISTINCTIVE APPEARANCE STANDS OUT FROM THE CLUTTER WITH EASE. ITS UNDULATING SHAPE CREATES A MAGICAL INTERPLAY OF LIGHT THAT ADDS TO ITS VISUAL APPEAL. THE COLOURS APPEAR DAZZLING, MESMERIZING AND EVEN PLAYFUL, DEPENDING ON THE PREVAILING LIGHT CONDITIONS. IT'S ONLY PHYSICS AT WORK, YOU'D SAY. REST ASSURED, NO ONE WOULD WANT TO BELIEVE YOU!

## COVERFRAME



### WEGA COVER PLATES WITH MOUNTING FRAMES

PLATES →	1M	2M	3M	4M	4M	6M	6M*	8M	8M*	8M	12M	18M
					(H&V)**		(H&V)**		(H&V)**	(V)		
COLOURS ↓	MRP ₹	MRP ₹	MRP ₹	MRP ₹	MRP ₹	MRP ₹	MRP ₹	MRP ₹	MRP ₹	MRP ₹	MRP ₹	MRP ₹
Pure Glossy	-	160.00	210.00	255.00	255.00	320.00	305.00	395.00	380.00	395.00	460.00	690.00
Metallic	-	240.00	280.00	340.00	340.00	390.00	375.00	480.00	465.00	480.00	650.00	830.00
VelvetTouch	-	330.00	380.00	460.00	460.00	540.00	525.00	685.00	670.00	685.00	900.00	1190.00
Wood	-	275.00	320.00	380.00	380.00	450.00	435.00	570.00	555.00	570.00	750.00	990.00
CODE →	200101	200201	200301	200401	200403	200601	200603	200801	200803	208801	201201	201801
PKG →	10	10	10	10	10	5	5	5	5	5	5	5
SIZE(mm) →	94x92	94x92	122x92	148x92	154x92	221x92	221x92	246x92	266x92	154x170	221x159	221x225

\*With Partition Plates

\*\*Suitable for Horizontal & Vertical Installation

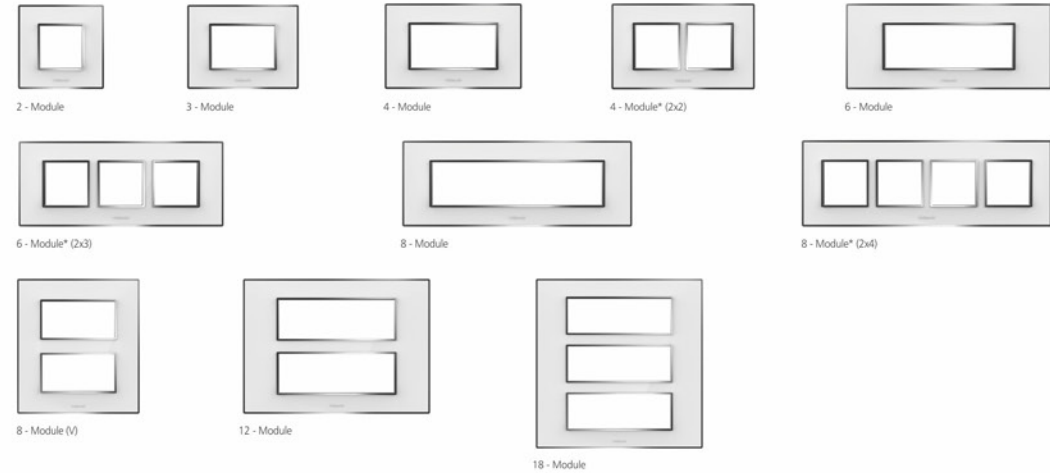

### WEGA MOUNTING FRAMES - Horizontal & Vertical Distance for Screwing (Dimensions in mm)

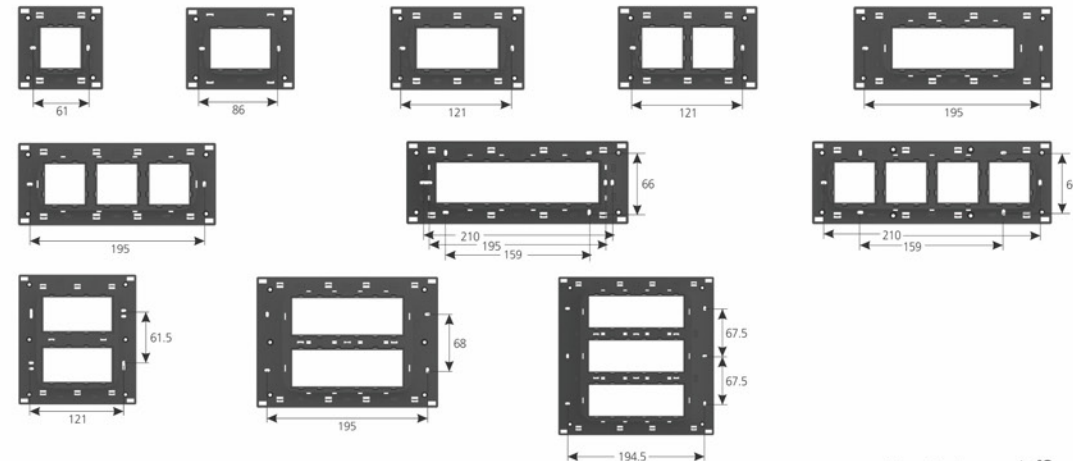

**GLASSIO COVER PLATES WITH MOUNTING FRAMES** NEW NEW

PLATES →	1M	2M	3M	4M	4M*	6M	6M*	8M	8M*	8M	9M*	12M	12M*	16M*	18M
					(H&V)**		(H&V)**		(H&V)**	(V)			(H&V)**		
COLOURS ↓	MRP ₹	MRP ₹	MRP ₹	MRP ₹	MRP ₹	MRP ₹	MRP ₹	MRP ₹	MRP ₹	MRP ₹	MRP ₹	MRP ₹	MRP ₹	MRP ₹	MRP ₹
Pure Glossy	92.00	92.00	114.00	139.00	139.00	199.00	199.00	252.00	252.00	252.00	270.00	288.00	288.00	324.00	367.00
Metallic	125.00	125.00	163.00	199.00	199.00	272.00	272.00	340.00	340.00	340.00	366.00	398.00	398.00	449.00	479.00
Metal Krome	186.00	186.00	260.00	316.00	316.00	423.00	423.00	569.00	569.00	569.00	580.00	584.00	584.00	642.00	677.00
VelvetTouch	182.00	182.00	248.00	305.00	305.00	408.00	408.00	558.00	558.00	558.00	566.00	572.00	572.00	627.00	666.00
Wood	166.00	166.00	226.00	277.00	277.00	378.00	378.00	518.00	518.00	518.00	526.00	530.00	530.00	587.00	619.00
CODE →	120101	120201	120301	120401	120404	120601	120604	120801	120804	128801	120901	121201	121204	121601	121801
PKG →	10	10	10	10	10	5	5	5	5	5	5	5	5	5	5
SIZE(mm) →	92x90	92x90	120x90	146x90	152x90	219x90	219x90	244x90	264x90	152x168	280x90	219x156	219x156	244x156	219x223

\*With Partition Plates      \*\*Suitable for Horizontal & Vertical Installation

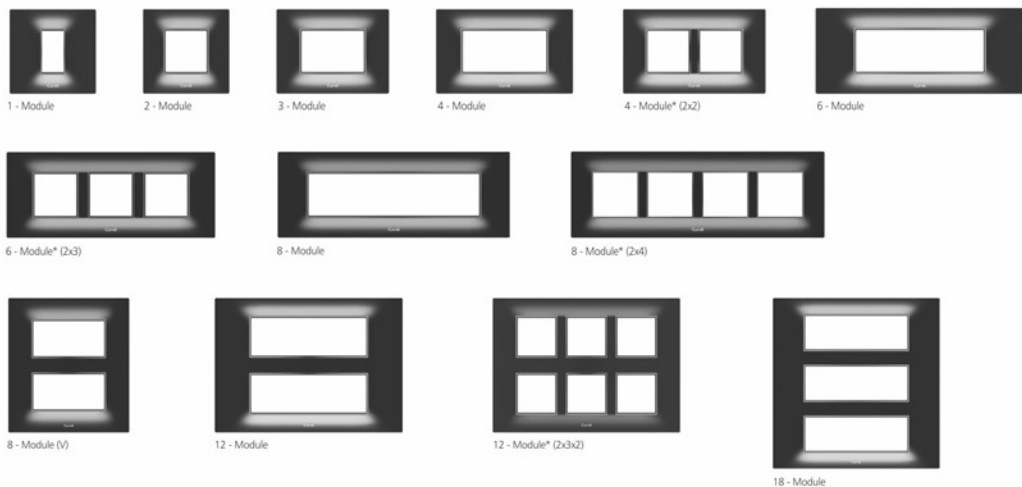

**GLASSIO MOUNTING FRAMES - Horizontal & Vertical Distance for Screwing ( Dimensions in mm )**

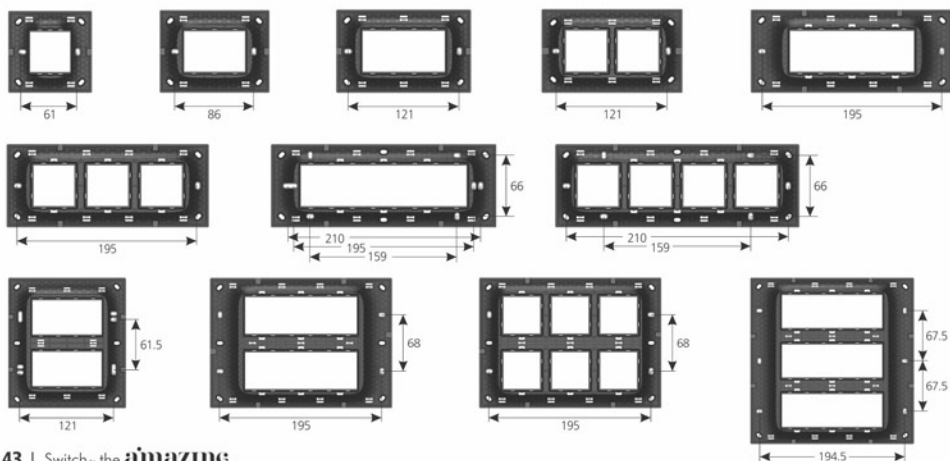

**COLOURS OF COVER PLATES**

*bella*



*Crisallo*

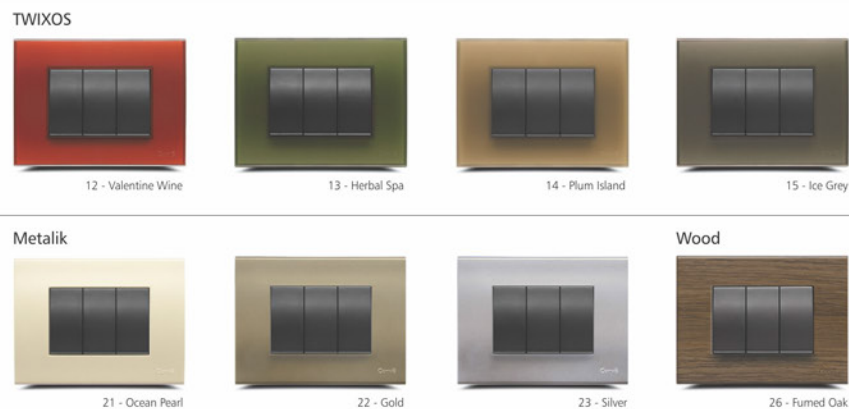

COLOURS OF COVER PLATES

PURE GLOSSY



01 - Absolute White



02 - Black Glossy



03 - Ivory Gold

METALLIC



06 - Gold Mist\*



07 - Digital Silver\*



08 - Digital Chrome\*

METAL KROME



11 - Hyper Chrome



12 - Satin Chrome\*



13 - Miami Gold\*



14 - Copper Cola\*



15 - French Wine\*



16 - Toronto Red\*



17 - Charcoal Brown\*

VELVET TOUCH



21 - Apple Green\*



22 - Mexican Peach\*



23 - Cherry Red\*



24 - Black Grape\*

WOOD



31 - Black Walnut



32 - Italian Espresso\*



33 - Zebra Wood\*



34 - Moughal Teak

COLOURS OF COVER PLATES

PURE GLOSSY



01 - Absolute White



02 - Black Glossy\*

**basic**

METALLIC



06 - Gold Mist\*



07 - Digital Silver

WOOD



11 - Wild Wenge\*



12 - Italian Espresso



13 - Zebra Wood



14 - Moughal Teak\*

PURE GLOSSY



20 - Absolute White



21 - Black Glossy\*

**premium**



COLOURS OF COVER PLATES

EXCLUSIVE

GLASS



CORIAN®



BASIC

METALLIC

BASIC WOOD



**basic**

GLASS



**premium**



25 - Hot Red



36 - Snow White\*



37 - Hot Red\*

Available only in 3 Module & 6 Module

*Divinity*

COLOURS OF COVER PLATES

Crystal*light*

GLASS



45 - Magic Mirror

PLUS



101 - Honey Dew

DIAMOND Crystal Studded



49 - Star Shine\*



50 - Night Sky\*

Available only in 3 Module

WOOD



56 - Wenge\*



57 - Sycamore\*



58 - Zebrano\*

**XTREME**

STEEL



81 - Brushed Steel\*



82 - Signature Steel\*

ALUMINIUM



86 - Brushed Black



87 - Brushed Silver

**FLUSH MOUNTING METAL GANG BOXES (GALVANIZED)**

GANG BOX →	1 & 2M	3M	4M	6M	8M(H)	8M(V)	12M	16M	18M
MRP ₹ ↓	59.00	78.00	96.00	119.00	155.00	155.00	195.00	240.00	275.00
CODE	70201	70302	70403	70604	70805	78806	71207	71608	71809
PKG	10	10	10	5	5	5	5	5	5
SIZE (WxHxL) mm	75x73x51	100x73x51	135x73x51	208x73x51	230x73x51	135x130x60	209x130x60	230x144x60	209x200x60

**METAL GANG BOXES**

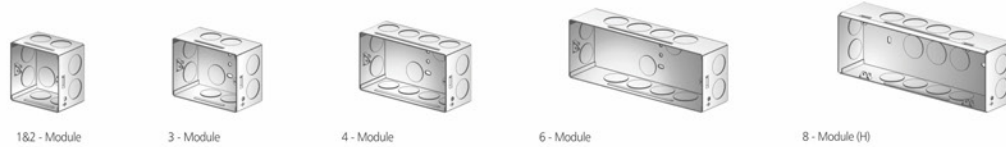

**FLUSH MOUNTING PLASTIC GANG BOXES (FIRE RESISTANT)**

GANG BOX →	1 & 2M	3M	4M	6M	8M(H)	8M(V)	12M	16M	18M
MRP ₹ ↓	52.00	60.00	72.00	94.00	109.00	109.00	151.00	177.00	215.00
CODE	80201	80302	80403	80604	80805	88806	81207	81608	81809
PKG	10	10	10	5	5	5	5	5	5
SIZE (WxHxL) mm	79x82x50	104x82x50	139x82x50	213x82x50	263x86x55	141x142x55	213x143x55	249x150x55	214x211x58

**PLASTIC GANG BOXES**

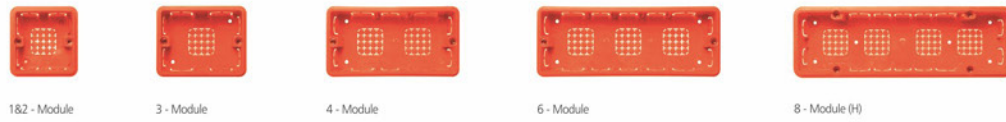

**SURFACE MOUNTING PLASTIC GANG BOXES (FIRE RESISTANT)**

GANG BOX →	1 & 2M	3M	3M	4M	6M	8M(H)	8M(V)	12M	16M	18M
MRP ₹ ↓	53.00	78.00	78.00	83.00	104.00	132.00	132.00	168.00	187.00	223.00
CODE	90201	90302	93303	90404	90605	90806	98807	91208	91609	91810
PKG	10	10	10	5	5	5	5	5	5	5
SIZE (WxHxL) mm	92x85x48	124x85x48	118x85x48	150x85x48	218x85x48	267x85x48	153x154x48	219x154x48	267x154x48	224x227x48

**PLASTIC SURFACE GANG BOXES**

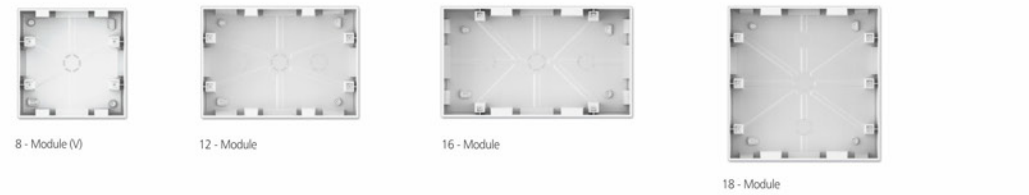
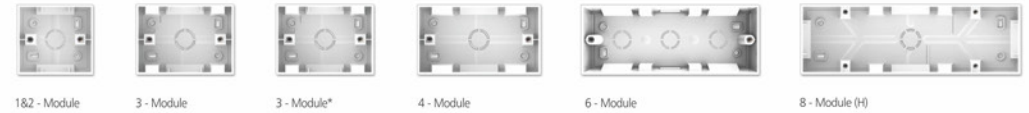

**G- SURFACE MOUNTING PLASTIC GANG BOXES (FIRE RESISTANT) Suitable for Grazia & Glassio** NEW

GANG BOX →	1 & 2M	3M	4M	4M (HV)	6M	8M(H)	8M(HV)	8M (V)	9M	12M	16M	18M
MRP ₹ ↓	57.00	87.00	96.00	96.00	122.00	159.00	159.00	159.00	180.00	196.00	227.00	265.00
CODE	100201	100302	100403	100404	100605	100806	100807	108808	100909	101212	101611	101812
PKG	10	10	10	5	5	5	5	5	5	5	5	5
SIZE (WxHxL) mm	91x89x48	119x89x48	145x89x48	150x89x48	218x89x48	243x89x48	263x89x48	154x155x48	279x89x48	218x155x48	243x155x48	218x222x48

**PLASTIC SURFACE GANG BOXES**

Note: Not suitable for Grazia 8M (V) Plate

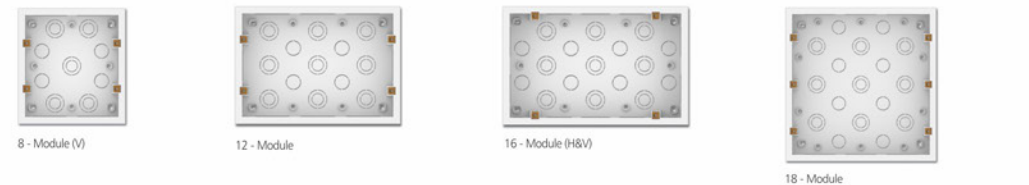

The smart way  
to light up your world.



LEDs  
Lighting

The LED lights by Goldmedal are designed to set new benchmarks in performance and aesthetics. Engineered for quick, cost-effective installation and easy retrofitting, these LED lights and panels are packed with features and benefits. All LED lights are also available in three basic colours: warm white, natural white and cool white. Select the colour that best suits your preference. Stylish in appearance, each of these lighting devices are durable enough to last years of use.

IS 15885 (Part 2/Sec 13)



High CRI



Power Factor



High Lumen



Mercury Free



Energy Saving



Ultra Slim



Power Saver



Compact

## SHOWROOMS

### MUMBAI

E-1, Laxmi Industrial Estate,  
New Link Road,  
Andheri West, Mumbai - 400053.  
Tel: +91-22-40031075  
Email: info@goldmedalindia.com

### KOLKATA

1/1B/4, Ramkrishna Naskar lane,  
Kolkata - 700010, West Bengal  
Tel: +91-33-23740039, 8336907040  
Email: Kolkata@goldmedalindia.com

### HYDERABAD

S-1, Ground Floor, Kalphakunja  
Apartment 5-2-84/87, Jambagh,  
Hyderabad-500095, Telangana  
Tel: +91-40-24610722 / 9849172122  
Email: gmhydsunil@yahoo.co.in

### VIJAYAWADA

D. NO. 11-33-15, Tatakulavari Street,  
Vijayawada-520 001, Andhra Pradesh  
Tel: +91-866-6542000 / 8977574737  
Email: vijayawada@goldmedalindia.com

### CHANDIGARH

302/A, 3rd Floor, Elante Mall,  
Chandigarh-160002, Punjab & Haryana  
Tel: +91-9216122131  
Email: info@virgomark.com

### AHMEDABAD

401, Amrutlal Pole, Opp. Bank of Baroda,  
Khadiya-Golwad, Ahmedabad-380001, Gujarat  
Tel: +91-79-22155201  
Email: ahmedabad@goldmedalindia.com

### MUMBAI

1, Floor-GDR, Plot-157-161, Zaveri Bldg,  
Shamaldas Gandhi Marg, Loharchawl,  
Kalbadevi, Mumbai - 400002.  
Tel: +91-22-39567558  
Email: info@goldmedalindia.com

### SILIGURI

International Market, 1st Floor,  
Shop No.1, Sevoke Road, Pani Tanki More,  
Beside Sky Dujin, Siliguri-734001, West Bengal.  
Tel: +91-9474588032  
Email: riteshg@goldmedalindia.com

### SECUNDERABAD

D.No. 7-3-693, Ground Floor, R.P. Road,  
Secunderabad - 500003, Telangana.  
Tel: +91-9490411665  
Email: info@goldmedalindia.com

### VIJAYAWADA

2nd Floor, PVP Mall, Mahatma Gandhi Rd,  
Labbipet, Vijayawada-520010, Andhra Pradesh  
Tel: +91-9885676400  
Email: vijayawada@goldmedalindia.com

### HUBBALLI

Umachagi Complex, Koppikar Road, Hubballi,  
Karnataka-580020  
Tel: +91-0836-4258466

Email: bangalore@goldmedalindia.com

### NOIDA

H-204, Sec-63  
Noida, Uttar Pradesh - 201307  
Tel: +91-120-4135901  
Email: noida@goldmedalindia.com

## BRANCHES

WEST

### MUMBAI

Shop No.20, 3rd Floor, Old Hanuman  
Lane, Dhanji Mulji Dela, Kalbadevi Road  
Marine Line, Mumbai-400002,  
Maharashtra. Tel: +91-22-39567558  
info@goldmedalindia.com

### MUMBAI

165/1315, Motilal Nagar - 1,  
Goregaon (W), Mumbai-400046,  
Maharashtra  
Tel: +91-22-28723911  
mumbai@goldmedalindia.com

### PALGHAR

Bldg. No.5, Shah Industrial Estate,  
Opp. Masjid, Mourya Naka, Sativalli,  
Vasai (E), Palghar-401208, Maharashtra  
Tel: +91-22-42023026  
mumbai@goldmedalindia.com

### AHMEDABAD

401, Amrutlal Pole, Opp,  
Bank of Baroda, Golwad, Khadia,  
Ahmedabad-380001, Gujarat  
Tel: +91-79-22155201  
ahmedabad@goldmedalindia.com

### PUNE

555/556, Shop No.3, Budhwar Peth,  
Shaligram Prasad, Tapkir Galli,  
Pune, Maharashtra - 411002  
Tel: +91-9130368776  
pune@goldmedalindia.com

### BHOPAL

Sector A-85, Behind Anant Shree  
Hospital, Indrapuri, Raisen Road,  
Bhopal, Madhya Pradesh - 462021  
Tel: +91-755-2580040  
bhopal@goldmedalindia.com

### RAIPUR

2nd Floor, GST Tower, Near Agrasen  
Bhawan, Jawahar Nagar, M.G. Road,  
Raipur-492001, Chhattisgarh.  
Tel: +91-771-4910078  
raipur@goldmedalindia.com

EAST

### KOLKATA

1/1B/4, Ram Krishna Naskar Lane  
Beliaghata, Kolkata - 700010  
West Bengal.  
Tel: +91-8336907040  
kolkata@goldmedalindia.com

### PATNA

Ground Floor, High Plot No.4H/59,  
Bahadurpur Housing Colony,  
Lohia Nagar, Agamkuan, Patna-800020  
Bihar. Tel: +91-9386897126  
patna@goldmedalindia.com

### RANCHI

R. S. Plot No.176, M. S. Plot No.748,  
Ground Floor, Shri Ramchandra  
Apartment, Jalan Road, Upper Bazar,  
Ranchi - 834001, Jharkhand  
Customer Care : 1800 209 0234  
ranchi@goldmedalindia.com

NORTH

### NEW DELHI

4/42, Subhash Galli, Vishwas Nagar  
Shahdara, New Delhi, Delhi - 110032  
Tel: +91-11-65251133  
delhi@goldmedalindia.com

### JODHPUR

G-651/652 M.I.A, 2nd Phase,  
Near Delhi Rajasthan Transport,  
Jodhpur, Rajasthan - 342005  
Tel: +91-9772210543  
rajasthan@goldmedalindia.com

### LUCKNOW

E - 57, 1st Floor, Transport Nagar,  
Lucknow - 226016, Uttar Pradesh  
Tel: +91-522-4233136  
lucknow@goldmedalindia.com

### NOIDA

H-204, Sec-63  
Noida, Uttar Pradesh - 201307  
Tel: +91-120-4135901  
noida@goldmedalindia.com

### DEHRADUN

108, Tagore Villa, Chakarata Road,  
Dehradun, Uttarakhand, 248001.  
Tel: +91-135-2651656  
dehradun@goldmedalindia.com

SOUTH

### BENGALURU

No.7, G.K. Temple street,  
Chickpet Cross, Bengaluru,  
Karnataka - 560053  
Tel: +91-80-41687799/41759977  
bangalore@goldmedalindia.com

### VIJAYAWADA

20-127/2, By Pass Road, Gollapudi,  
Krishna District, Vijayawada - 521225,  
Andhra Pradesh  
Tel: +91-866-6542333/6542888  
vijayawada@goldmedalindia.com

### HYDERABAD

Central Warehouse Corporation  
A2, P B No 34, Behind Gandhi Bhavan,  
Nampally, Hyderabad - 500001,  
Telangana  
Tel: +91-40-29706099  
hydteam@goldmedalindia.com

### CHENNAI

92/6, Nattu Pillaiar Koil Street  
Sowcarpet, Chennai,  
Tamil Nadu - 600001  
Tel: +91-44-49521008  
chennai@goldmedalindia.com

NOW  
TURN TO THE END  
TO BROWSE THE  
GIFA PRODUCTS  
RANGE

GOLDMEDAL  
18  
CREATION



180°

NOW  
TURN TO THE END  
TO BROWSE THE  
GOLDMEDAL  
PRODUCTS RANGE

180°

# Live Innovative



2018

PRODUCTS  
& PRICING MANUAL  
APR 2018 - EDITION 01  
www.gifaworld.com





[www.gifaworld.com](http://www.gifaworld.com)

**live innovative**

WHETHER IT'S AN EVERYDAY TASK OR A UNIQUE CHALLENGE THAT LIFE THROWS AT YOU, GIFA WANTS YOU TO THINK AND DO INNOVATIVE. TO IMAGINE THE LIFE YOU DESERVE AND TO MAKE IT POSSIBLE THROUGH INNOVATION, IMAGINATION AND CREATIVITY. THE GIFA RANGE OF MODULAR SWITCHES AND SYSTEMS IS A HARBINGER OF THIS CHANGE IN THINKING. WITH ITS SLEEK, INTUITIVE, MINIMALISTIC INTERFACE AND MANY THOUGHTFUL FEATURES, THIS MODULAR RANGE OF PRODUCTS BY GIFA WILL INSPIRE AND DELIGHT YOU IN MANY WAYS.

LIVE FREE. LIVE INNOVATIVE.

## Ultimate Sophistication

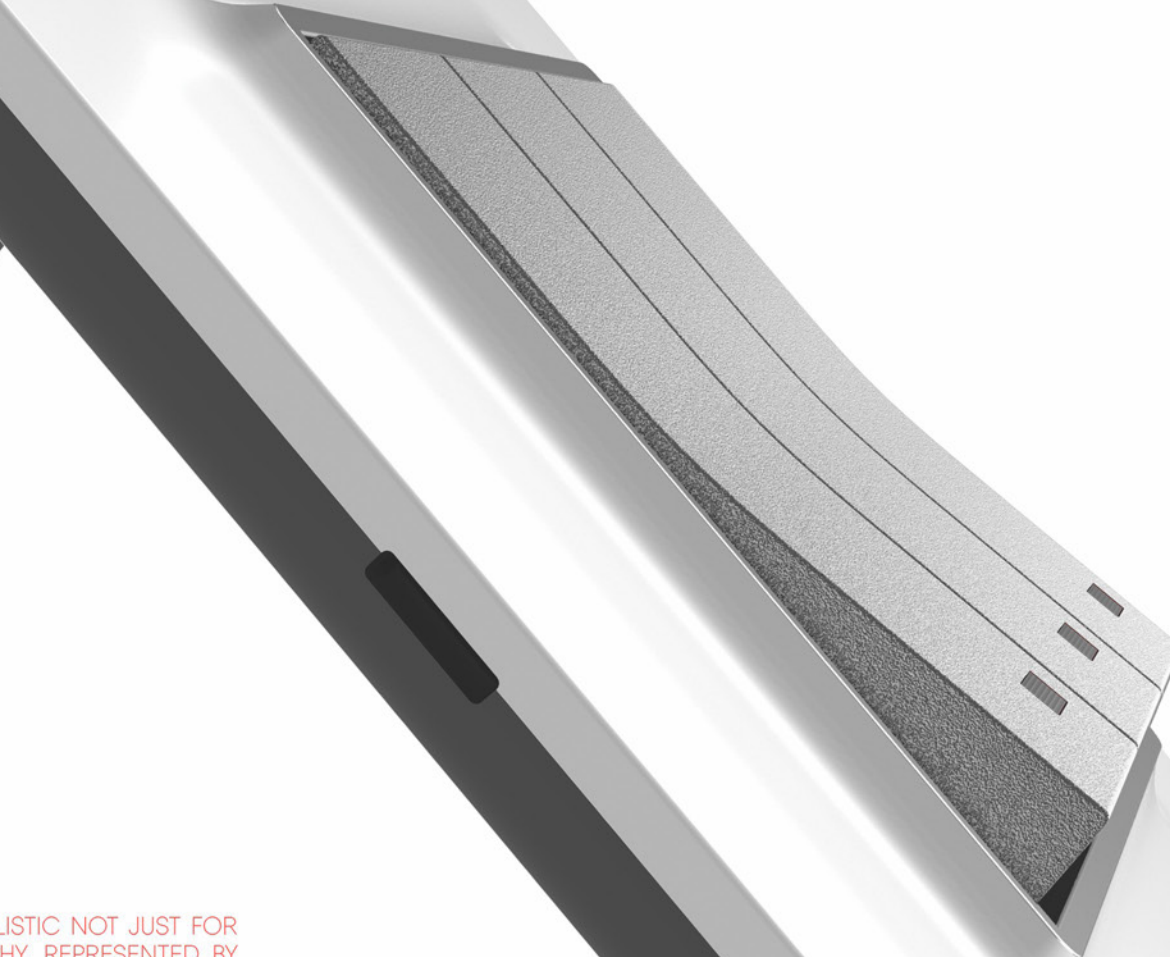

THE GIFA RANGE OF MODULAR INSERTS IS MINIMALISTIC NOT JUST FOR AESTHETIC PURPOSES BUT AS A DESIGN PHILOSOPHY. REPRESENTED BY CLEAR STRAIGHT LINES, CRISP FINISHES AND MINIMUM FLOURISHES, THESE INSERTS ARE PERFECTLY STREAMLINED FOR OPTIMUM FUNCTIONALITY. DEEP THOUGHT HAS BEEN GIVEN TO THE CONFIGURATION AND PURPOSE OF EACH PRODUCT. THE END RESULT IS AN EFFORTLESS SYMPHONY OF FORM WITH FUNCTION AND CLASS WITH COMFORT THAT WILL SURPRISE AND DELIGHT YOU ON AN EVERY DAY BASIS.



# Passion Unlimited

GIFA HAS BEEN DESIGNED WITH A PASSION TO DELIGHT YOU WITH ITS EASE OF OPERATION, ITS WONDERFULLY SOPHISTICATED APPEARANCE AND ITS EXCITING RANGE OF FUNCTIONS. EXPERIENCE THE INTENSITY OF THIS PASSION WITH THE VIBRANT FERRARI RED COVER PLATES. A STRONG, STIMULATING HUE, THE FERRARI RED ADDS JUST THE RIGHT AMOUNT OF SPICE TO PERK UP YOUR ENERGY LEVELS.

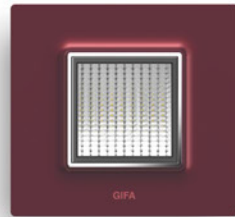
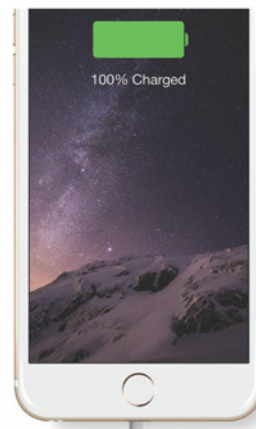

## SMART PASSIVE INFRARED DETECTOR

APTLY NAMED, THE SMART PIR IS EQUIPPED WITH THE RIGHT AMOUNT OF GREY CELLS TO SWITCH DEVICES ON AND OFF AS PER YOUR NEED. WALK INTO ITS PERIPHERAL VISION AND IT POWERS ON CONNECTED DEVICES; MOVE OUT OF ITS ZONE AND IT CUTS OFF POWER. ADJUSTABLE DUSK/DAWN SENSORS ALONG WITH USER DEFINED THRESHOLDS AND TIME DELAYS ENSURE THAT THIS PRESENCE DETECTOR MAKES NO MISTAKE WHILE CARRYING OUT ITS DUTIES. PRECISE STRAIGHT LINES AND WELL PLACED BUTTONS MINGLE WITH PERFECTLY CLEAR MARKINGS FOR THAT BALANCED, AESTHETIC LOOK.

## LIGHTING FITTING WITH EMERGENCY FUNCTION

THIS LIGHTING UNIT PLAYS A DUAL ROLE: PROVIDING ILLUMINATION AT VARIOUS INTENSITIES AS PER YOUR NEED AND SWITCHING ON AUTOMATICALLY IN THE EVENT OF A POWER FAILURE. OPERATED WITH BATTERIES IN CASE YOU WANT TO AVAIL OF ITS EMERGENCY LIGHTING FUNCTION, THE PRODUCT CAN ALSO BE USED AS A PURE LIGHTING DEVICE WITHOUT BATTERIES. THE MATERIALS USED, THE CLEAN DESIGN AND THE SIMPLICITY OF OPERATION IS ALONG THE LINES OF OTHER CLOUD 9 PRODUCTS.

## GALAXY FAN REGULATOR & USB CHARGER

THE 5-STEP REGULATOR BY CLOUD 9 IS FINELY CALIBRATED TO CONTROL FAN SPEED. ITS PRECISE MOVEMENTS REDUCES DISTORTION OF THE FAN'S MOTOR, ENSURES LOWER HEATING AND LONGER LIFE FOR THE FAN. ITS UNIQUE CAPSULE KNOB IN CHROME FINISH NOT ONLY OFFERS BETTER GRIP BUT ALSO MAKES IT THE FOCUS OF ATTENTION ON ANY SWITCH PANEL. THE USB CHARGER SOCKET IS A DEFINITE LIFESAVER IN TODAY'S WORLD. SUITABLE FOR DEVICES LIKE MOBILE PHONES, DIGITAL CAMERAS, LAPTOPS, TABLETS AND MORE, THIS USB CHARGER CAN BE FLUSH-MOUNTED ON ANY CLOUD 9 COVER PLATE AND DEMONSTRATES THE VERY BEST OF MINIMALISTIC DESIGN.

## I-WAVE SWITCH

THE I-WAVE SWITCH BY CLOUD 9 IS AS INNOVATIVE AND ACCESSIBLE AS ANY MODULAR INSERT CAN BE. TO SWITCH ON THE DEVICE, SIMPLY WAVE YOUR HAND IN FRONT OF IT. WAVE AGAIN, TO SWITCH IT OFF. THERE'S NO PHYSICAL CONTACT NEEDED WHATSOEVER. WITH JUST A SINGLE, CIRCULAR, TRANSLUCENT ELEMENT SERVING AS THE FOCAL POINT OF INTERACTION, THE I-WAVE SWITCH IS A CLASSIC EXAMPLE OF CLEAN, FUNCTIONAL AND DELIGHTFULLY RESTRAINED DESIGN.

## ELECTRONIC BUZZER & I-PUSH STEP MARKER

THE ELECTRONIC BUZZER IS SIMPLICITY PERSONIFIED WITH A MINIMALISTIC INTERFACE THAT ALERTS YOU THROUGH ACOUSTIC AND VISUAL SIGNALS. AVAILABLE IN THREE DIFFERENT COLOURS AND CRAFTED USING HIGH QUALITY MATERIALS, THE ELECTRONIC BUZZER CAN BE OF USE IN HOMES AS WELL AS OFFICES. THE I-PUSH STEP MARKER IS ANOTHER EXCITING PRODUCT THAT CAN SERVE MULTIPLE PURPOSES. USEFUL TO LIGHT UP PATHWAYS AND CORRIDORS, THEY CAN ALSO BE USED AS FOCUS LIGHTS TO ACCENTUATE THE HIGHLIGHTS OF YOUR INTERIORS. A GENTLE PUSH IS ALL THAT'S NEEDED TO SWITCH IT ON. THE STEP MARKER POPS OUT AND REMAINS ON UNTIL YOU PUSH IT BACK INTO THE COVER PLATE.

## MECHANICAL KEYTAG

THE MECHANICAL KEY TAG BY CLOUD 9 WILL BE AN INTELLIGENT INCLUSION FOR INSTITUTIONS IN THE HOSPITALITY INDUSTRY. EXQUISITELY MINIMALISTIC WITH A SEAMLESSLY INTEGRATED CARD SLOT, THE DEVICE ALLOWS EASY INGRESS AND EGRESS TO RESIDENTS. AVAILABLE IN THREE SHADES - ABSOLUTE WHITE, TITANIUM SILVER AND TITANIUM GREY, THIS DEVICE CAN SUIT THE AESTHETIC REQUIREMENTS OF ANY INTERIOR.

Code	Item	MRP ₹		Pkg.	Code	Item	MRP ₹		Pkg.
		White	Metallic				White	Metallic	
<b>6AX / 10AX SWITCHES 240V~ (1 Module) GLINE</b>					<b>6AX / 10AX SWITCHES 240V~ (1 Module) GSLIDE</b>				
GF011001	1 Way Switch	63.00	69.00	20	GF011401	1 Way Switch	63.00	69.00	20
GF011002	1 Way Switch with Indicator (LED)	108.00	119.00	20	GF011402	1 Way Switch with Indicator (LED)	108.00	119.00	20
GF011003	2 Way Switch	108.00	119.00	20	GF011403	2 Way Switch	108.00	119.00	20
GF011004	Bell Push Switch	114.00	125.00	20	GF011404	Bell Push Switch	114.00	125.00	20
GF011005	Bell Push Switch with Indicator (LED)	131.00	144.00	20	GF011405	Bell Push Switch with Indicator (LED)	131.00	144.00	20
<b>6AX / 10AX SWITCHES 240V~ (2 Module) GLINE</b>					<b>6AX / 10AX SWITCHES 240V~ (2 Module) GSLIDE</b>				
GF012010	1 Way Switch	126.00	139.00	10	GF012410	1 Way Switch	126.00	139.00	10
GF012011	1 Way Switch with Indicator (LED)	143.00	157.00	10	GF012411	1 Way Switch with Indicator (LED)	143.00	157.00	10
GF012012	2 Way Switch	158.00	174.00	10	GF012412	2 Way Switch	158.00	174.00	10
GF012013	Bell Push Switch	149.00	164.00	10	GF012413	Bell Push Switch	149.00	164.00	10
GF012014	Bell Push Switch with Indicator (LED)	169.00	186.00	10	GF012414	Bell Push Switch with Indicator (LED)	169.00	186.00	10
GF012015	Bell Push Switch with Luminous Name Plate	231.00	254.00	10					
	240V~ 50-60Hz LED circuit with diffuser								
<b>20AMP / 25AMP SWITCHES 240V~ (1 Module) GLINE</b>					<b>20AMP / 25AMP SWITCHES 240V~ (1 Module) GSLIDE</b>				
GF011020	20A 1 Way Switch	145.00	160.00	20	GF011420	20A 1 Way Switch	145.00	160.00	20
GF011021	20A 1 Way Switch with Ind. (LED)	162.00	178.00	20	GF011421	20A 1 Way Switch with Indicator	162.00	178.00	20
GF011022	20A 2 Way Switch	162.00	178.00	20	GF011422	20A 2 Way Switch	162.00	178.00	20
GF011023	25A 1 Way Switch	175.00	193.00	20	GF011423	25A 1 Way Switch	175.00	193.00	20
<b>20AMP / 25AMP SWITCHES 240V~ (2 Module) GLINE</b>					<b>20AMP / 25AMP SWITCHES 240V~ (2 Module) GSLIDE</b>				
GF012025	20A 1 Way Switch	175.00	193.00	10	GF012425	20A 1 Way Switch	175.00	193.00	10
GF012026	20A 1 Way Switch with Ind. (LED)	194.00	213.00	10	GF012426	20A 1 Way Switch with Ind. (LED)	194.00	213.00	10
GF012027	20A 2 Way Switch	210.00	231.00	10	GF012427	20A 2 Way Switch	210.00	231.00	10
GF012028	25A 1 Way Switch	220.00	242.00	10	GF012428	25A 1 Way Switch	220.00	242.00	10
<b>32AMP DP SWITCHES 240V~ (2 Module) GLINE</b>					<b>32AMP DP SWITCHES 240V~ (2 Module) GSLIDE</b>				
GF012031	32A DP Switch with Indicator (LED)	289.00	318.00	10	GF012431	32A DP Switch with Indicator (LED)	289.00	318.00	10

Code	Item	MRP ₹		Pkg.	Code	Item	MRP ₹		Pkg.
		White	Metallic				White	Metallic	
<b>6AMP / 10AMP SOCKETS 240V~</b>					<b>AUDIO - VIDEO SOCKET (1 Module)</b>				
GF011035	6A 2 Pin Socket (1M) with safety shutter	95.00	105.00	20	GF011075	Triple RCA Socket (Audio & Video)	660.00	720.00	10
GF012037	6A 2x1 Socket (2M) with safety shutter	122.00	134.00	10	GF011076	HDMI Socket	1000.00	1102.00	5
GF012039	10A International Socket (2M) with safety shutter	196.00	216.00	10	<b>SINGLE POLE MCBS 240/450V~ (1 Module)</b>				
GF012040	6A Universal Socket (2M) with mobile socket & safety shutter	141.00	155.00	10	GF011077	C6 SP MCB	270.00	307.00	20
					GF011078	C10 SP MCB	270.00	307.00	20
					GF011079	C16 SP MCB	270.00	307.00	20
					GF011080	C20 SP MCB	270.00	307.00	20
					GF011081	C25 SP MCB	270.00	307.00	20
					GF011082	C32 SP MCB	270.00	307.00	20
					240/450V~ 50-60Hz 3.0kA Breaking Capacity				
<b>6&amp;16AMP / 6&amp;25AMP SOCKETS 240V~ (2 Module)</b>					<b>DOUBLE POLE MCBS 240/450V~ (2 Module)</b>				
GF012041	6&16A Universal Socket with safety shutter	219.00	241.00	10	GF011084	C6 DP MCB	545.00	600.00	10
GF012042	6&25A Universal Socket with safety shutter	226.00	249.00	10	GF011085	C10 DP MCB	545.00	600.00	10
GF012044	6&25A Universal Socket with flap & Indicator	305.00	335.00	10	GF011086	C16 DP MCB	545.00	600.00	10
					GF011087	C20 DP MCB	545.00	600.00	10
					GF011088	C25 DP MCB	545.00	600.00	10
					GF011089	C32 DP MCB	545.00	600.00	10
					240/450V~ 50-60Hz 3.0kA Breaking Capacity				
<b>DIMMER / FAN REGULATOR 240 V~ (1 Module)</b>					<b>INDICATOR / FUSE UNIT / BLANK MODULE (1 Module)</b>				
GF011045	Dimmer 240V 50-60Hz 300-450W	272.00	299.00	20	GF011093	Indicator with LED & Red Diffuser	97.00	107.00	20
GF011049	Step Regulator 4 Step, 240V 50-60 Hz	413.00	454.00	20	GF011098	Fuse Carrier (10Amp/16Amp) with miniature fuse dia 6.3x28	133.00	146.00	20
					GF011125	Blank Module	27.00	30.00	50
<b>GALAXY FAN REGULATOR 240V~ (2 Module)</b>					<b>STEP MARKER</b>				
GF012050	Fan Regulator - Half Rotary	451.00	-	10	GF012104	LED Step Marker (2M) Supply voltage 240V~ 50-60Hz	480.00	530.00	5
GF012051	Fan Regulator - Full Rotary	451.00	-	10	GF012105	i-Push Step Marker (2M) Supply voltage 240V~ 50-60Hz with high-efficiency 2x0.5W LED	1089.00	1198.00	5
GF012052	Fan Regulator - Half Rotary(Chr. Knob)	-	511.00	10	GF013106	Step Marker (3M) Supply voltage 240V~ 50-60Hz with high-efficiency 2x0.5W LED	554.00	609.00	5
GF012053	Fan Regulator - Full Rotary (Chr. Knob)	-	511.00	10	<b>LIGHTING FITTING WITH EMERGENCY FUNCTION</b>				
					GF012110	Lighting Fitting with Emergency Function (2M) with High Efficiency 2x0.5W LED & 3 Steps	1012.00	1113.00	5
					GF013111	Lighting Fitting with Emergency Function (3M) with High Efficiency 3x0.5W LED & 3 Steps	1426.00	1568.00	5
					Dimming Switch 240V~ 50Hz when battery is inserted, the device will function as an emergency light - Battery not included (101124)				
<b>MOTOR STARTER (SP) 240V~ 50-60Hz (2 Module)</b>					<b>TV SOCKET / RJ-11 TELEPHONE JACKS / EDP SOCKET (1 Module)</b>				
GF012058	10A Motor Starter Switch	519.00	571.00	10	GF011066	TV Socket Coaxial 40-862 Mhz Socket	114.00	125.00	20
GF012059	16A Motor Starter Switch	519.00	571.00	10	GF011068	Telephone Jack - RJ 11	124.00	136.00	20
GF012060	20A Motor Starter Switch	519.00	571.00	10	GF011072	EDP Socket Outlet - RJ 45 (5e) Category 5e, Universal wiring T568A, insulating-piercing terminal	216.00	238.00	20
GF012061	25A Motor Starter Switch	519.00	571.00	10	GF011074	EDP Socket Outlet - RJ 45 (6e) Category 6e, Universal wiring T568A, insulating-piercing terminal	545.00	600.00	20

Code	Item	MRP ₹		Pkg.	Code	Item	MRP ₹		Pkg.
		White	Metallic				White	Metallic	
<b>EMERGENCY LIGHT BATTERY</b>					<b>SMART PASSIVE INFRARED DETECTOR (2 Module)</b>				
101124	Battery Li-ion, 3.6V 600mAh 2/3A (A Curve Modular Product)	249.00	-	20	GF012212*	Smart Passive Infrared Detector with infrared sensor, auto on/off, adjustable dusk/dawn sensor threshold and time delay cycle, supply voltage 240V~50-60Hz 6A relay output	1649.00	1819.00	5
<b>ELECTRONIC BELL 240V~ (2 Module)</b>					<b>I - DOCK PLAYER (4 Module)</b>				
GF012139	Electronic Bell 240V~50-60Hz	342.00	376.00	10	GF014280	I-Dock Player Supply voltage 240V~, Inbuilt stereo amplifier : 2 x 4W, charging function for Iphone 5, 5S, 5C, 6, 6S, 6Plus, I-pod Touch & I-Pad Air, Gesture control for music & cell phone communication, SIRI enabled. Can be connected to any music system, home audio system, speakers i.e ceiling or inwall through amplifier via Line out (Aux out)	10900.00	11900.00	5
<b>32A MAIN SWITCH (2 Module)</b>					<b>GALAXY DOCK PLAYER (4 Module)</b>				
GF012163	32A DP Operated by Key Tag 240V~, LED Supplied with Key Tag	498.00	548.00	10	GF014281	Galaxy Dock Player Supply voltage 240V~, Inbuilt stereo amplifier : 2 x 4W, charging function for Samsung S2 and above compatible with charger. Gesture control for music & cell phone communication, S-Voice enabled. Can be connected to any music system, home audio system, speakers i.e ceiling or inwall through amplifier via Line out (Aux out)	10900.00	11900.00	5
GF012164	Only Key Tag with Name Plate	102.00	112.00	20					
<b>25A ELECTRONIC BADGE SWITCH (3 Module)</b>					<b>STEREOPHONIC SPEAKER (2 Module)</b>				
GF013165	Electronic Switch with Smart Card 25A 240V~ 50-60Hz with indicator (LED) & Integral relay having exit delay.	1621.00	1783.00	5	GF012306	Stereophonic Speaker - 2piece set Stereophonic loud Speaker Output : 4W Impedance : 4 ohms	1549.00	1719.00	5
GF013166	Smart Card Customizable Smart Card	125.00	-	20	<b>ROUTER + EXTENDER (3 Module)</b>				
<b>DND/MAKE MY ROOM (2 Module)</b>					GF013322	Wi-Fi Router + Extender 300 MBPS wi-fi wireless router with Ethernet port, In-built USB port for internet connectivity and charging devices. Also support 4G dongle.	7899.00	8699.00	5
GF012168	Do Not Disturb/Make My Room 240V~ 50-60Hz - Inside Room	478.00	525.00	10					
GF012169	Do Not Disturb/Make My Room 240V~ 50-60Hz - Outside Room	511.00	562.00	10					
<b>UNIVERSAL USB CHARGER 240V~</b>									
GF 011172	USB Charger (1M) Supply voltage 160-240V~ 50-60Hz Output - 5V DC, 1000mA or 1A	1000.00	1102.00	5					
GF012173	Dual Port USB Charger (2M) Supply voltage 160-240V~ 50-60Hz Output - 5V DC, 2000mA or 2A	1240.00	1355.00	5					
GF013174	Dual Port USB Charger with Ind. & 10A International Socket (3M) Supply voltage 160-240V~ 50-60Hz Output - 5V DC, 2000mA or 2A	1432.00	1575.00	5					
<b>I-WAVE SWITCH 240V~ (2 Module)</b>									
GF012201*	I-Wave Switch Electronic Sensor switch Supply voltage 160-240V~ 6A relay output Allows to control lights by simply passing the hand in front of it (Max distance 50mm). Upto 5 Switches can be combined to control the same lighting circuit.	4399.00	4899.00	5					

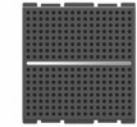
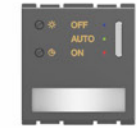

**F9 COVER PLATES WITH MOUNTING FRAMES**

PLATES →	1M	2M	3M	3M*	4M	4M*	6M	6M*	8M	8M*	8M	8M*	12M	12M*	16M*	18M
						(H&V)**		(H&V)**		(H&V)**	(V)	(H&V)		(H&V)**		
COLOURS ↓	MRP ₹	MRP ₹	MRP ₹	MRP ₹	MRP ₹	MRP ₹	MRP ₹	MRP ₹	MRP ₹	MRP ₹	MRP ₹	MRP ₹	MRP ₹	MRP ₹	MRP ₹	MRP ₹
Pure Glossy	84.00	84.00	104.00	104.00	127.00	127.00	181.00	181.00	230.00	230.00	230.00	230.00	263.00	263.00	297.00	336.00
Metallic	131.00	131.00	170.00	170.00	207.00	207.00	283.00	283.00	355.00	355.00	355.00	355.00	414.00	414.00	469.00	501.00
Wood	178.00	178.00	243.00	243.00	297.00	297.00	405.00	405.00	556.00	556.00	556.00	556.00	599.00	599.00	631.00	664.00
CODE →	GF30101	GF30201	GF30301	GF30303	GF30401	GF30403	GF30601	GF30603	GF30801	GF30803	GF38801	GF38803	GF31201	GF31203	GF31601	GF31801
PKG →	10	10	10	10	10	10	5	5	5	5	5	5	5	5	5	5
SIZE(mm) →	98x91	98x91	121x91	121x91	146x91	152x91	220x91	220x91	245x90	275x90	152x168	152x168	220x157	220x157	245x157	220x222

\* With Partition Plates      \*\*Suitable for Horizontal & Vertical Installation

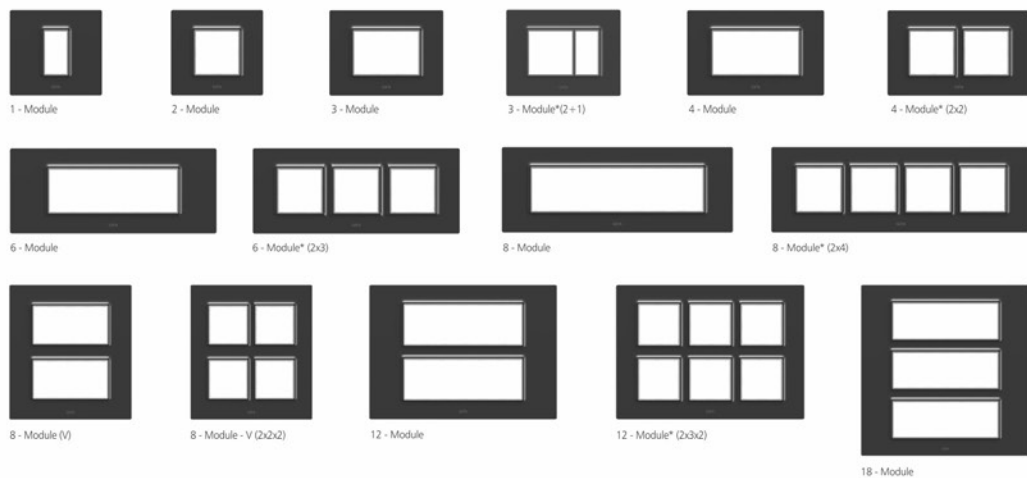

**F9 MOUNTING FRAMES - Horizontal & Vertical Distance for Screwing (Dimensions in mm)**

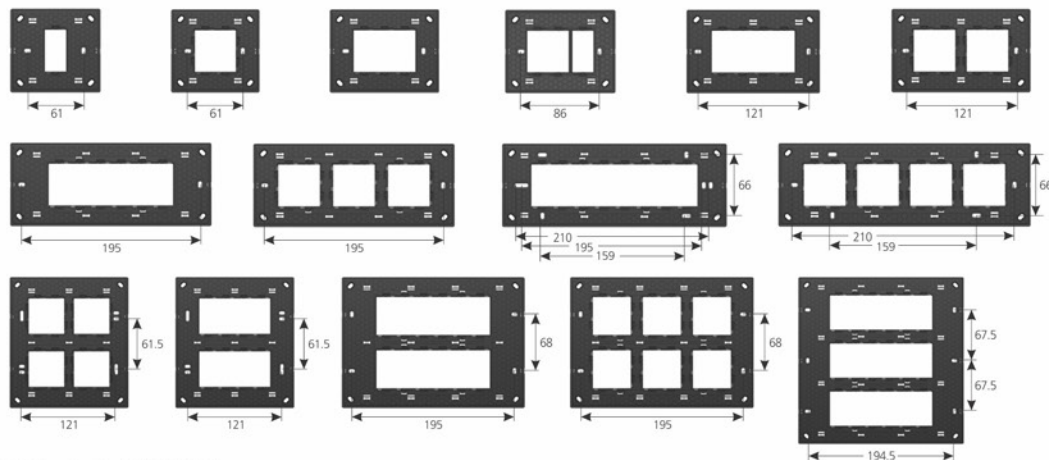

**FLUSH MOUNTING METAL GANG BOXES (GALVANIZED)**

GANG BOX →	1 & 2M	3M	4M	6M	8M(H)	8M(V)	12M	16M	18M
MRP ₹ ↓	62.00	82.00	101.00	125.00	163.00	163.00	205.00	252.00	289.00
CODE	GF70201	GF70302	GF70403	GF70604	GF70805	GF78806	GF71207	GF71608	GF71809
PKG	10	10	10	5	5	5	5	5	5
SIZE (WxHxL) mm	75x73x51	100x73x51	135x73x51	208x73x51	230x73x51	135x130x60	209x130x60	230x144x60	209x200x60

**METAL GANG BOXES**

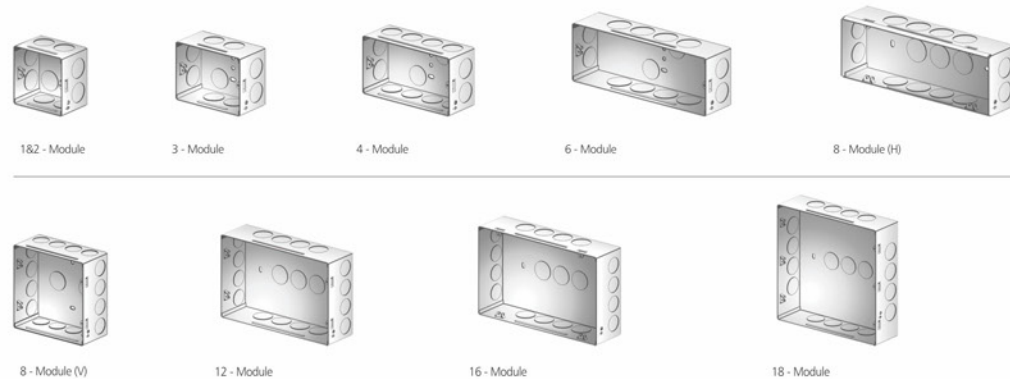

F9  
PLATES DEFINE YOUR WORLD WITH COLOURS

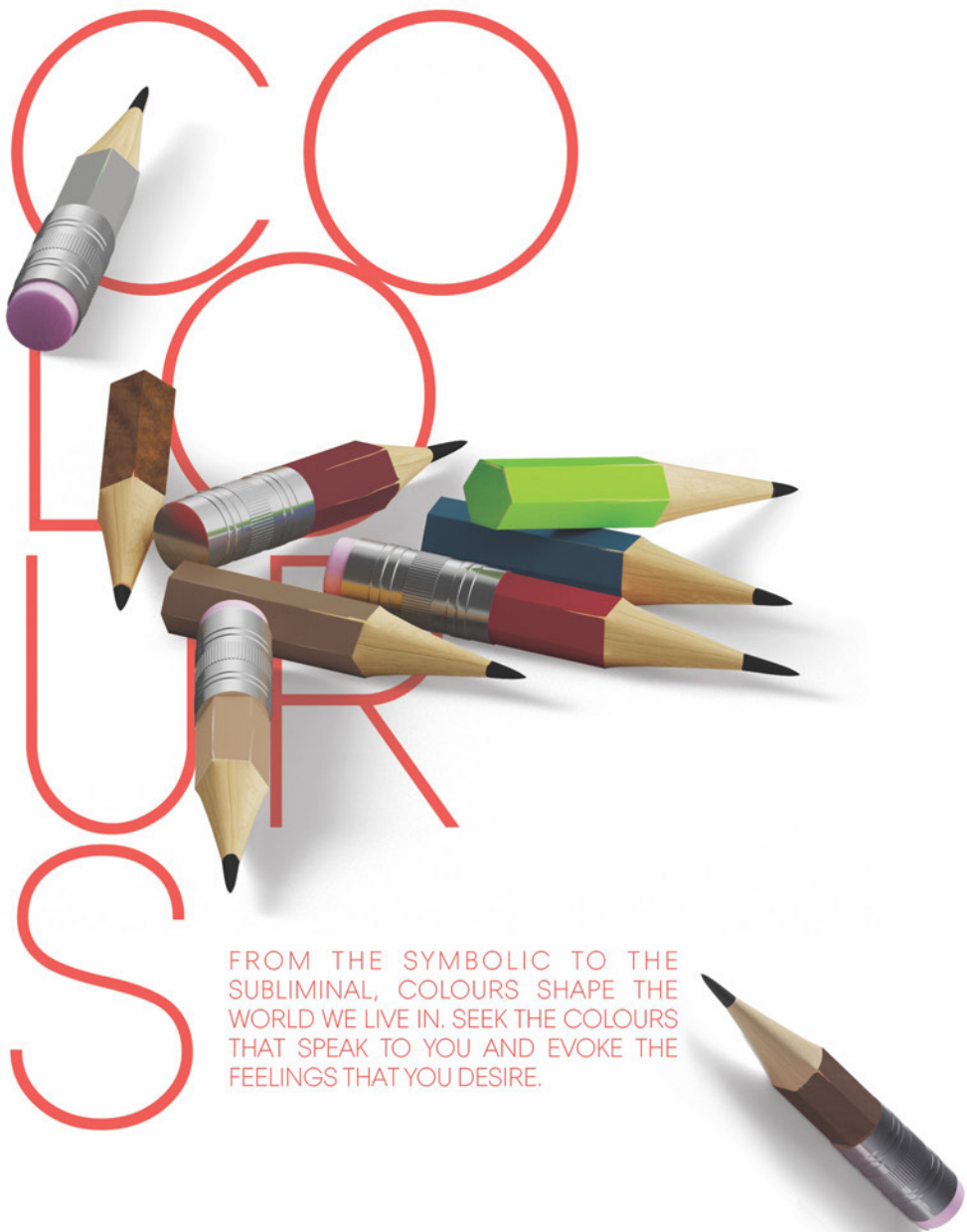

FROM THE SYMBOLIC TO THE  
SUBLIMINAL, COLOURS SHAPE THE  
WORLD WE LIVE IN. SEEK THE COLOURS  
THAT SPEAK TO YOU AND EVOKE THE  
FEELINGS THAT YOU DESIRE.

PURE GLOSSY



01 - Absolute White



02 - Black Glossy

METALLIC



06 - Titanium Silver



07 - Titanium Grey



08 - Champagne Gold



09 - Copper Silk



10 - Android Green\*



11 - Air Force Blue



12 - Ferrari Red

WOOD



31 - Fuzzy Brown



32 - Dark Apricot



33 - Chocolate Wood

\* Introducing shortly



ADD A BIT OF THE NATURAL WORLD TO YOUR INTERIORS WITH THESE COVER PLATES IN WOOD ACCENTS. WHETHER IT'S LIGHT OR DARK WOOD, ADDING A BIT OF THIS WONDROUS MATERIAL MAKES ANY INTERIOR FEEL WARMER AND INVITING. THE AFRICAN WENGE WOOD COVER PLATE HAS A MAJESTIC, LUXURIOUS APPEAL TO IT WHILE THE FUMED OAK AND ROSE WOOD COVER PLATES ARE MODERN AND CHEERFUL IN THEIR APPEARANCE. COMBINE THEM WITH THE INSERTS OF YOUR CHOICE TO CREATE THAT DISTINCTIVE LOOK FOR YOUR INTERIORS.



Code	Item	MRP ₹		Pkg.	Code	Item	MRP ₹		Pkg.
		White/Grey	Metallic				White/Grey	Metallic	
<b>6AX / 10AX SWITCHES / 6A INDICATOR</b>					<b>RJ-11 TELEPHONE JACK / RJ-45 MODEM JACK</b>				
GF 14101	1 Way Switch	18.00	20.00	20	GF 14138	RJ-11 2 Line Telephone Jack	70.00	77.00	20
GF 14102	2 Way Switch	30.00	33.00	20	GF 14139	RJ-11 4 Line Telephone Jack	94.00	103.00	10
GF 14103	Bell Push Switch	30.00	33.00	20	GF 14140	RJ-45 Outlet for Computer	240.00	264.00	10
GF 14104	Indicator (LED)	30.00	33.00	20		Category 6e, Universal wiring T568A, insulating-piercing terminal			
<b>6AMP BELL PUSH 240V~</b>					<b>KIT-KAT FUSE / LED NIGHT LAMP</b>				
GF 14116	Bell Push with Luminous Name Plate 240V~50-60Hz LED circuit with diffuser	132.00	146.00	10	GF 14144	Kit-Kat Fuse (Suitable for both 10A & 16A)	57.00	62.00	10
					GF 14150	Night Lamp (LED)	132.00	145.00	10
<b>6A &amp; 10A SOCKETS / 13A INTERNATIONAL SOCKET</b>					<b>10AMP SWITCH SOCKET COMBINED 240V~</b>				
GF 14118	6A 2 Pin Socket with safety shutter	33.00	36.00	20	GF 14151*	10A Switch Socket Combined (with indicator)	72.00	78.00	10
GF 14119	10A 2 In One Socket	39.00	43.00	10	GF 14152*	10A Switch Socket Combined with Junction Box (with indicator)	94.00	102.00	10
GF 14121	13A International Socket with safety shutter	58.00	63.00	10					
<b>TV ANTENNA SOCKETS</b>					<b>20AMP SWITCHES / GAMA SWITCHES 240V~</b>				
GF 14125	Mini TV Antenna Socket with card-grip configuration	48.00	53.00	20	GF 14153	20A 1 Way Switch	99.00	109.00	10
GF 14126	Medium TV Antenna Socket with card-grip configuration	51.00	56.00	20	GF 14154	20A 2 Way Switch	112.00	122.00	10
					GF 14155	20A Gama 1 Way Switch with indicator	112.00	122.00	10
					GF 14156	20A Gama 2 Way Switch	133.00	146.00	10
<b>ELECTRONIC DIMMER / GALAXY REGULATOR 240V~</b>					<b>10AX GAMA BELL PUSH / 6&amp;16A SOCKET 240V~</b>				
GF 14129	300W Mini Dimmer	170.00	187.00	10	GF 14157	10AX Gama Bell Push with indicator	82.00	90.00	10
GF 14130	300W Medium Dimmer	185.00	203.00	10	GF 14158	6&16A Universal Socket with safety shutter	105.00	115.00	10
GF 14131	EME 4 Step Fan Regulator	260.00	285.00	10					
GF 14132	Galaxy 5 Step Fan Regulator - Full Rotary	285.00	315.00	10					
GF 14133	Galaxy 5 Step Fan Regulator - Half Rotary	285.00	315.00	10					
<b>GALAXY REGULATOR WITH CHROME KNOB 240V~</b>					<b>32AMP DP SWITCH 240V~</b>				
GF 14134	Galaxy 5 Step Fan Regulator - Full Rotary	295.00	325.00	10	GF 14161	32AMP DP Switch with indicator	180.00	198.00	5
GF 14135	Galaxy 5 Step Fan Regulator - Half Rotary	295.00	325.00	10					

\*introducing shortly



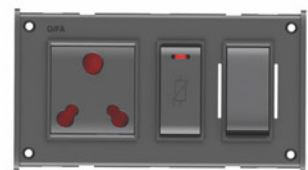

Code	Item	MRP ₹		Pkg.
		White/Grey	Metallic	
<b>6&amp;16A 3 IN ONE COMBINED 240V~</b>				
GF 14165	6&16A 3 In One Switch Socket Combined	191.00	210.00	5
GF 14166	6&16A 3 In One Switch Socket Combined with junction box	220.00	240.00	5
	with safety shutter			
<b>6&amp;16A 5 IN ONE COMBINED 240V~</b>				
GF 14167	6&16A 5 In One Switch Socket Combined with fuse & indicator	239.00	260.00	5
GF 14168	6&16A 5 In One Combined with junction box	275.00	302.00	5
	with safety shutter			
<b>LAMP HOLDER / CEILING ROSE 240~</b>				
GF 02101	Zuloo Angle Holder (Plastic) Advanced Interlock Configuration	47.00	-	20
GF 02102	Zuloo Batten Holder (Plastic) Advanced Interlock Configuration	47.00	-	20
GF 02103	Igloo Angle Holder (Metal) Advanced Interlock Configuration	52.00	-	20
GF 02104	Igloo Batten Holder (Metal) Advanced Interlock Configuration	52.00	-	20
GF 02116	Pilot Ceiling Rose Auto Safe Lock	36.00	-	20
GF 02117	Jumbo Ceiling Rose Auto Safe Lock	43.00	-	20

Code	Item	MRP ₹		Pkg.
		White/Grey		
<b>10AX SWITCH COVER PLATES</b>				
GF 14175	Platina	4.25		100
GF 14176	Metaliq	6.75		100
GF 14177	Wood	7.25		100
	SUITABLE FOR: 10AX Switches, Indicator, Mini Jack, Mini Dimmer, Mini Step Regulator & Fuse Unit etc.			
<b>10A SOCKET COVER PLATES</b>				
GF 14181	Platina	5.75		100
GF 14182	Metaliq	8.50		100
GF 14183	Wood	9.25		100
	SUITABLE FOR: 10A Sockets, Bell Push, Night Lamp, Med Dimmer, 5 Step Regulator & 4 Line Telephone Jack etc.			
<b>10A S S COMBINED COVER PLATES</b>				
GF 14184*	Platina	25.00		50
GF 14185*	Metaliq	32.00		50
GF 14186*	Wood	36.00		50
	SUITABLE FOR: 10 Switch Socket Combined			
<b>20A SWITCH COVER PLATES</b>				
GF 14187	Platina	17.50		50
GF 14188	Metaliq	24.00		50
GF 14189	Wood	27.00		50
	SUITABLE FOR: 20A Switches			
<b>16A SOCKET COVER PLATES</b>				
GF 14193	Platina	20.00		50
GF 14194	Metaliq	27.00		50
GF 14195	Wood	30.00		50
	SUITABLE FOR: 20A Gama Switch, 10AX Gama Bell Push & 32A DP Switch etc.			
<b>3 IN ONE COVER PLATES</b>				
GF 14199	Platina	29.00		25
GF 14200	Metaliq	37.00		25
GF 14201	Wood	41.00		25
	SUITABLE FOR: 3 In One Combined			
<b>5 IN ONE COVER PLATES</b>				
GF 14205	Platina	39.00		25
GF 14206	Metaliq	52.00		25
GF 14207	Wood	60.00		25
	SUITABLE FOR: 5 In One Combined			
AVAILABLE COLOURS IN BASE :		AVAILABLE COLOURS IN PLATES		
Digital Silver, White Jazz & Carbon Grey		Platina : White Jazz & Ivory Metaliq : Gold, Digital Silver, Olive Green & Copper Cola Wood : Fumed Oak, African Wenge & Rose Wood		

